

**IZELTAS®** 55.yil

KATALÓGUS



2024

100

MILLI MÜCADELE'NİN YÜZÜNCÜ YILI

YERLİ  
ÜRETİM



İZELTAŞ USTA İŞİ  
SOHBETLER



İZELTAŞ YOUTUBE

## Pro Széria műhely kocsi ( 5-6-7-8 fiókos ) Pro Series Workshop Trolley ( 5-6-7-8 Drawers )



✓ Központi zárási rendszer, fogantyúzárral és dőlésgátló rendszerrel ellátva

- Central lock system, handgrip lock system and antitilt system.



✓ 100%-ban kihúzható teleszkópos sínek

- Telescopic slides which are %100 extendable.



✓ 8 rekeszes, robusztus ABS asztal

- Durable ABS worktop with 8 divisions



✓ 2 fékes forgókerékkel 2 fix kerekek

- 2 swivel castors with brake, 2 fixed castors  
Ø 125mm



✓ Magas szilárdságú elektrosztatikus porfestés

- High strength electrostatic powder coating







Méret/Size: 470x670x1007 mm

Fémről készült,  
elektrosztatikus festéssel bevont  
Made of sheet metal, Electrostatic paint

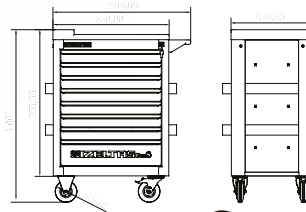
✓ 6 szerszámtartó

- 6 tool holders

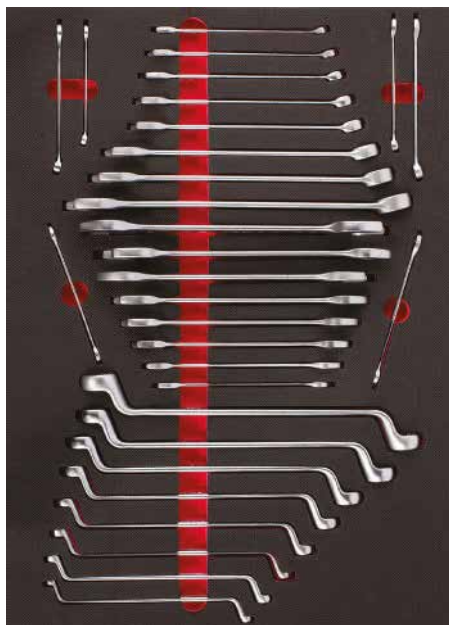

| KÓD<br>CODE              | Fiókok<br>DRAWERS |  |  |  |  | Színek<br>COLORS |  |
|--------------------------|-------------------|---|---|---|---|------------------|--|
|                          |                   | 400x548x68  | 400x548x143   | 400x548x218   |   |                  |  |
| 8241 32 1005             | 5                 | 1X  | 4X  | --  | 59  |                  |  |
| 8241 32 1006             | 6                 | 4X  | 1X  | 1X  | 62  |                  |  |
| 8241 32 1007             | 7                 | 5X  | 2X  | --  | 65  |                  |  |
| 8241 32 1008             | 8                 | 7X  | 1X  | --  | 67  |                  |  |
| 8241 32 2005             | 5                 | 1X  | 4X  | --  | 59  |                  |  |
| 8241 32 2006             | 6                 | 4X  | 1X  | 1X  | 62  |                  |  |
| 8241 32 2007             | 7                 | 5X  | 2X  | --  | 65  |                  |  |
| 8241 32 2008             | 8                 | 7X  | 1X  | --  | 67  |                  |  |
| 8241 32 3005             | 5                 | 1X  | 4X  | --  | 59  |                  |  |
| 8241 32 3006             | 6                 | 4X  | 1X  | 1X  | 62  |                  |  |
| 8241 32 3007             | 7                 | 5X  | 2X  | --  | 65  |                  |  |
| 8241 32 3008             | 8                 | 7X  | 1X  | --  | 67  |                  |  |
| 8241 00 1209 Teljes/Full | 206 db/Pcs        | 8   | 7X  | 1X  | --  |                  |  |

**1. FIÓK / Drawer**
**KÓD / Code 8241001030**

| KÓD<br>CODE | TARTALMA<br>CONTENTS  |    |
|-------------|---|----|
| 0130        | Villáskulcs / D/E Open Jaw Wrench Long Pattern<br>6x7 - 8x9 - 10x11 - 12x13<br>14x15 - 16x17 - 18x19 - 20x22<br>21x23 - 24x26 | 10 |
| 0330        | Csillag-Villáskulcs / Combination Wrench Long Pattern<br>6 - 7 - 8 - 9 - 10 - 11 - 12 - 13<br>14 - 17 - 19 - 22               | 12 |
| 0430        | Csillagkulcs / D/E Ring Wrench<br>6x7 - 8x9 - 10x11 - 12x13<br>14x15 - 16x17<br>18x19 - 20x22                                 | 8  |

**2. FIÓK / Drawer**
**KÓD / Code 8241002072**

| KÓD<br>CODE | TARTALMA<br>CONTENTS  |    |
|-------------|---|----|
| 1107        | 1/4" dugókulcs készlet / 1/4" Socket Wrench Set<br>4 - 5 - 6<br>7 - 8 - 9 - 10<br>11 - 12 - 13<br>Hat lapú csavarhoz<br>Six Point                     | 15 |
| 1113        | 1/2" Dugókulcs készlet / 1/2" Socket Wrench Set<br>10 - 11 - 12<br>13 - 14 - 15<br>16 - 17 - 18<br>19 - 21 - 22<br>23 - 24 - 26<br>27 - 28 - 30<br>32 | 24 |
| 1113        | 1/2" Imbusz bitek / 1/2" Hexagonal Bits Sockets<br>H5-H6-H7-H8-H10-H12-H14  | 7  |
| 1113        | 1/2" Torx bitek / 1/2" Star Bits Socket<br>T20-T25-T27-T30-T40-T45-T50-T55-T60  | 9  |
| 0330        | Csillag-villás kulcsok, hosszú / Combination Wrench Long 16-18  | 2  |
| 4900        | Imbusz kulcskészlet / Hex Key Wrench Set<br>2-2,5-3-3,5-4-5-6-7-8-9-10-12   | 12 |

**3. FIÓK / Drawer**
**KÓD / Code 8241003051**

| KÓD<br>CODE | TARTALMA<br>CONTENTS   |    |
|-------------|--|----|
| 07415       | 3 soros drótkéfe / Hand Brush 3 Rows   | 1  |
| 6350        | Gumi szerelővas 400 mm / Tyre Lever 400 mm   | 1  |
| 6220        | Mágneses csavarfelszedő, flexi / Flexible Magnet Holder 500 gr                     | 1  |
| 4110        | Csavarhúzó, lapos / Screwdriver, Stubby, Flat 6.5x25                               | 1  |
| 4130        | Csavarhúzó, kereszt, Philips / Screwdriver, Stubby, Philips 6x25                   | 1  |
| 4770        | Behajtó 6-7-8-9-10-13 / Nutspinner 6-7-8-9-10-13                                   | 6  |
| 4780        | Csavarhúzó, mágneses bitbefogóval / Screwdriver, Magnetic Bit Holder               | 1  |
| 4905        | Imbuszkulcs, gömbfejű, készlet / Hexkey Wrench Ballpoint Set<br>2-2,5-3-4-5-6-8-10 | 8  |
| 4800        | Bit készlet, dobozban / Bits Set in Plastic Case                                   | 31 |



#### 4. FIÓK / Drawer

KÓD / Code 8241004027

| KÓD<br>CODE | TARTALMA<br>CONTENTS  |    |  |
|-------------|---|----|--|
| 0340        | Villáskulcs - racsnis csillagkulcs kombi / Combination Wrench With Ratchet<br>10-13-17-19     | 4  |  |
| 4909        | Torx T csavarhúzók / Torx Allen Key T type<br>T9-T10-T15-T20-T25-T27-T30-T40                  | 8  |  |
| 1108        | 1/2" Dugókulcs, hosszú / 1/2" Deep Socket Wrench, six points<br>10-11-12-13-14-15-16-17-18-19 | 10 |  |
| 1113        | 1/2" Dugókulcs, rövid / 1/2" Impact Socket Wrench<br>13-17-18-19-24                           | 5  |  |



#### 5. FIÓK / Drawer

KÓD / Code 8241005010

| KÓD<br>CODE | TARTALMA<br>CONTENTS  |   |  |
|-------------|---|---|--|
| 3331        | Seeger fogó, belső, hajlított / Circlip Pliers, Internal, Bent 170 mm | 1 |  |
| 3321        | Seeger fogó, belső, egyenes / Circlip Pliers, Internal, Flat 180 mm   | 1 |  |
| 3311        | Seeger fogó, külső, hajlított / Circlip Pliers, External, Bent 170 mm | 1 |  |
| 3301        | Seeger fogó, külső, egyenes / Circlip Pliers, External, Flat 180 mm   | 1 |  |
| 3700        | Oldalvágó fogó 160 mm / Side Cutting Pliers, 160 mm                   | 1 |  |
| 3220        | Csőrősfogó / Nose Pliers, 200 mm                                      | 1 |  |
| 3020        | Kombinált fogó / Combination Pliers, 180 mm                           | 1 |  |
| 2510        | Patent fogó / Special Grip 250 mm                                     | 1 |  |
| 0600        | Állítható kulcs / Adjustable Jaw Wrench 10"                           | 1 |  |
| 2400        | Vízpumpa fogó / Waterpump Pliers Universal 240 mm                     | 1 |  |



#### 6. FIÓK / Drawer

KÓD / Code 8241006018

| KÓD<br>CODE | TARTALMA<br>CONTENTS   |   |  |
|-------------|--|---|--|
| 4300        | Csavarhúzó lapos / Opak Screwdriver, Flat<br>4x100-5x125-6x150-8x175 | 4 |  |
| 4320        | Csavarhúzó, kereszt Ph /Opak Screwdriver, Philips<br>4.5x80-6x100    | 2 |  |
| 5800        | Kalapács 300 gr / Mechanist Hammer 300 gr                            | 1 |  |
| 5850        | Plasztik Kalapács o300 gr / Plastic Hammer o30                       | 1 |  |
| 5545        | Lyukasztó 5 mm / Drift Punch 5 mm                                    | 1 |  |
| 5550        | Csapszegkiütő 5 mm / Split Pin Punch 5 mm                            | 1 |  |
| 5540        | Pontozó 5x120 / Center Punch 5x120                                   | 1 |  |
| 5500        | Hidegvágó, lapos 150 mm / Flat Cold Chisel 150 mm                    | 1 |  |
| 4920        | T- Imbuszkulcs / T Type Hex Key Wrench 3-4-5-6-7-8                   | 6 |  |



İZELTAŞ YOUTUBE

## Garage Széria műhely kocsi ( 5-6-7-8 fiókos )



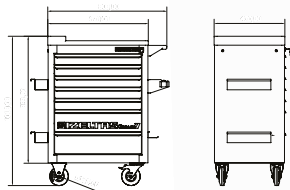



## Workshop Trolley ( 5-6-7-8 Drawers )

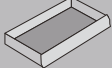

Méret/Size: 470x670x1010 mm

Fémből készült,  
elektrosztatikus festéssel bevont  
Made of sheet metal, Electrostatic paint



| KÓD<br>CODE            | Fiókok<br>DRAWERS |  |  |  | Kg | Színek<br>COLORS  |
|------------------------|-------------------|---|---|---|----|---|
|                        |                   | 400x548x68  | 400x548x143   | 400x548x218   |    |   |
| 8242 32 1005           | 5                 | 1X  | 4X  | --  | 59 |   |
| 8242 32 1006           | 6                 | 4X  | 1X  | 1X  | 62 |  |
| 8242 32 1007           | 7                 | 5X  | 2X  | --  | 65 |   |
| 8242 32 1008           | 8                 | 7X  | 1X  | --  | 67 |   |
| 8242 32 2005           | 5                 | 1X  | 4X  | --  | 59 |   |
| 8242 32 2006           | 6                 | 4X  | 1X  | 1X  | 62 |  |
| 8242 32 2007           | 7                 | 5X  | 2X  | --  | 65 |   |
| 8242 32 2008           | 8                 | 7X  | 1X  | --  | 67 |   |
| 8242 32 3005           | 5                 | 1X  | 4X  | --  | 59 |   |
| 8242 32 3006           | 6                 | 4X  | 1X  | 1X  | 62 |  |
| 8242 32 3007           | 7                 | 5X  | 2X  | --  | 65 |   |
| 8242 32 3008           | 8                 | 7X  | 1X  | --  | 67 |   |
| 8242 00 1142           | 7                 | 5X  | 2X  | --  |    |   |
| Teljes/Full 139 db/Pcs |                   |   |   |   |    |   |
| 8242 00 8142           | 8                 | 7X  | 1X  | --  |    |   |

## ✓ Ergonomikus fogantyú

- Ergonomic handle

✓ Tartós  
ABS munkalap osztásokkal

- Durable ABS worktop with divisions

✓ Papírtekerés-tartó x1,  
palack- és konzervtartó x2,  
akasztó x1

- Paper Roll Holder x1  
Bottle & Tins Holder x2  
Hanger x1

✓ 100%-ban kihúzható  
teleszkópos sínek

- %100 extendable telescopic slides

✓ Központi zárási rendszer,  
fogantyúzárral,  
és dőlésgátló rendszerrel

- Central locking,  
system handgrip lock system  
antitilt system

✓ 2 fékes forgókerékkel  
2 fix görgő

- 2 swivel castors with  
brake 2 fixed castors  
Ø 125 mm

✓ Magas szilárdságú  
elektrosztatikus porfestés

- High strength  
electrostatic  
powder coating

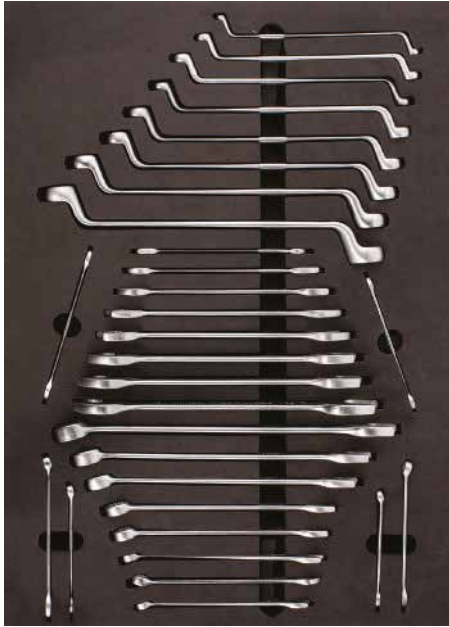

**1. FIÓK / Drawer**
**KÓD / Code 8242001030**

| KÓD<br>CODE | TARTALMA<br>CONTENTS   | ☐  |
|-------------|--|----|
| 0130        | Villáskulcs D/E Open Jaw Wrench Long Pattern<br>6x7 - 8x9 - 10x11 - 12x13<br>14x15 - 16x17 - 18x19 - 20x22 - 21x23 - 24x26 | 10 |
| 0330        | Csillag-villáskulcs Combination Wrench Long Pattern<br>6 - 7 - 8 - 9 - 10 - 11 - 12 - 13 - 14 - 17 - 19 - 22               | 12 |
| 0430        | Csillagkulcs D/E Ring Wrench<br>6x7 - 8x9 - 10x11 - 12x13 - 14x15 - 16x17 - 18x19 - 20x22                                  | 8  |

**2. FIÓK / Drawer**
**KÓD / Code 8242002072**

| KÓD<br>CODE | TARTALMA<br>CONTENTS   | ☐  |
|-------------|--|----|
| 1113        | 1/2" Imbusz bitek / 1/2" Hexagonal Bits Sockets<br>H5-H6-H7-H8-H10-H12-H14   | 7  |
| 1113        | 1/2" Torx bitek / 1/2" Star Bits Socket<br>T20-T25-T27-T30-T40-T45-T50-T55-T60   | 9  |
| 0330        | Csillag-villáskulcs / Combination Wrench Long<br>16-18   | 2  |
| 4900        | Imbusz kulcskészlet / Hex Key Wrench Set<br>2-2.5-3-3.5-4-5-6-7-8-9-10-12  | 12 |
| 1107        | 1/4" dugókulcs készlet / 1/4" Socket Wrench Set<br>4 - 5 - 6<br>7 - 8 - 9 - 10<br>11 - 12 - 13<br>Hat lapú csavarhoz<br>Six Point  | 15 |
| 1113        | 1/4" racsnis hajtókar / 1/4" Ratchet Handle<br>1/4" csuklós közdarab / 1/4" Universal Joint<br>1/2" T hajtókar /<br>1/2" Sliding T Handle Adapter<br>1/2" Dugókulcsok / 1/2" Socket Wrench Set<br>1/4" racsnis hajtókar / 1/4" Ratchet Handle<br>1/4" csuklós közdarab / 1/4" Universal Joint<br>1/2" Toldat hosszabító kar /<br>1/2" Extension Bar 125-250 mm | 24 |
|             | 10 - 11 - 12<br>13 - 14 - 15<br>16 - 17 - 18<br>19 - 21 - 22<br>23 - 24 - 26<br>27 - 28 - 30<br><b>32</b>  |    |





**3. FIÓK / Drawer**
**KÓD / Code 8242003010**

| KÓD<br>CODE | TARTALMA<br>CONTENTS  | <input type="checkbox"/> |  |
|-------------|---|--------------------------|--|
| 3331        | Seeger fogó, belse, hajlított / Circlip Pliers, Internal, Bent 170 mm | 1                        |  |
| 3321        | Seeger fogó, belse, egyenes / Circlip Pliers, Internal, Flat 180 mm   | 1                        |  |
| 3311        | Seeger fogó, külső, hajlított / Circlip Pliers, External, Bent 170 mm | 1                        |  |
| 3301        | Seeger fogó, külső, egyenes / Circlip Pliers, External, Flat 180 mm   | 1                        |  |
| 3700        | Oldalvágó fogó 160 mm / Side Cutting Pliers, 160 mm                   | 1                        |  |
| 3220        | Csőrősfogó / Nose Pliers, 200 mm                                      | 1                        |  |
| 3020        | Kombinált fogó / Combination Pliers, 180 mm                           | 1                        |  |
| 2510        | Patent fogó / Special Grip 250 mm                                     | 1                        |  |
| 0600        | Állítható kulcs / Adjustable Jaw Wrench 10"                           | 1                        |  |
| 2400        | Vízpumpafogó / Waterpump Pliers Universal 240 mm                      | 1                        |  |

**4. FIÓK / Drawer**
**KÓD / Code 8242004018**

| KÓD<br>CODE | TARTALMA<br>CONTENTS   | <input type="checkbox"/> |  |
|-------------|--|--------------------------|--|
| 4300        | Csavarhúzó lapos / Opak Screwdriver, Flat<br>4x100-5x125-6x150-8x175 | 4                        |  |
| 4320        | Csavarhúzó, kereszt Ph / Opak Screwdriver, Philips<br>4.5x80-6x100   | 2                        |  |
| 5800        | Kalapács 300 gr / Mechanist Hammer 300 gr                            | 1                        |  |
| 5850        | Plasztik Kalapács o300 gr / Plastic Hammer o30                       | 1                        |  |
| 5545        | Lyukasztó 5 mm / Drift Punch 5 mm                                    | 1                        |  |
| 5550        | Csapszegkiütő 5 mm / Split Pin Punch 5 mm                            | 1                        |  |
| 5540        | Pontozó 5x120 / Center Punch 5x120                                   | 1                        |  |
| 5500        | Hidegvágó, lapos 150 mm / Flat Cold Chisel 150 mm                    | 1                        |  |
| 4920        | T- Imbuszkulcs / T Type Hex Key Wrench 3-4-5-6-7-8                   | 6                        |  |

**5. FIÓK / Drawer**
**KÓD / Code 8242005011**

| KÓD<br>CODE | TARTALMA<br>CONTENTS  | <input type="checkbox"/> |  |
|-------------|---|--------------------------|--|
| 07415       | 3 soros drótkéfe /<br>Hand Brush 3 Rows                             | 1                        |  |
| 6350        | Gumi szerelővas 400 mm /<br>Tyre Lever 400 mm                       | 1                        |  |
| 6220        | Mágneses csavarfeszítő, flexi /<br>Flexible Magnet Holder 500 gr    | 1                        |  |
| 4110        | Csavarhúzó, lapos /<br>Screwdriver, Stubby, Flat 6.5x25             | 1                        |  |
| 4130        | Csavarhúzó, kereszt, Philips /<br>Screwdriver, Stubby, Philips 6x25 | 1                        |  |
| 4770        | Behajtó 6-7-8-9-10-13 /<br>Nutspinner 6-7-8-9-10-13                 | 6                        |  |



İZELTAS YOUTUBE

## Partner Széria műhely kocsi ( 5 fiókos )

Partner Workshop Trolley ( 5 Drawers )



✓ Központi zárrendszer és kézi zárrendszer

- Central lock system and handgrip lock system



✓ 100%-ban kihúzható teleszkópos sínek

- Telescopic slides which are %100 extendable.



✓ 8 rekeszes, robusztus ABS asztal

- 8 Durable ABS worktop with divisions



✓ 2 fékes forgókerékkel  
2 fix görgő

- 2 swivel castors with brake  
2 fixed castors ø100 mm



✓ Nagy szilárdságú elektrosztatikus porfestés

- High strength electrostatic powder coating

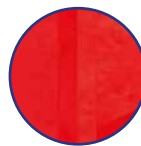

Méret/Size: 470x670x975 mm

Fémről készült,  
elektrosztatikus festéssel  
bevonat

Made of sheet metal,  
electrostatic paint

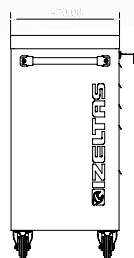
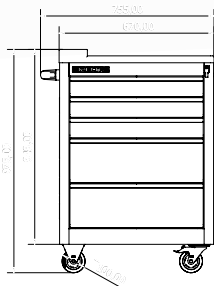







RAL 3020

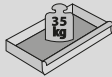

RAL 5003



RAL 9005

| KÓD/CODE                                   | Fiókok<br>DRAWERS |  35 kg |  35 kg |  Kg | Színek<br>COLORS  |
|--|-------------------|---|---|---|---|
| 8235 32 6005                               | 5                 | 3X  | 2X  | 56  |  |
| 8235 32 5005                               | 5                 | 3X  | 2X  | 56  |  |
| 8235 32 7005                               | 5                 | 3X  | 2X  | 56  |  |
| 8235 00 6121<br>Dolu/Full<br>118 Parça/Pcs | 5                 | 3X  | 2X  |   |   |



| KÓD<br>CODE | TARTALMA<br>CONTENTS  |    |
|-------------|---|----|
| 1107        | <p><b>1/4" dugókulcs készlet</b><br/>/ 1/4" Socket Wrench Set</p> <p><b>1/4" racsnis hajtókar /</b><br/>1/4" Ratchet Handle</p> <p><b>1/4" csuklós közdarab /</b><br/>1/4" Universal Joint</p> <p><b>1/4" T hajtókar /</b><br/>1/4" Sliding T Handle</p> <p><b>Toldal, hosszabító /</b><br/>Extension Bar 50-100 mm</p> <p>4 - 5 - 6<br/>7 - 8 - 9 - 10<br/>11 - 12 - 13</p> <p><b>Hat lapú csavarhoz</b><br/><i>Six Point</i></p>                | 15 |
| 1113        | <p><b>1/2" Dugókulcsok /</b><br/>1/2" Socket Wrench Set</p> <p><b>1/2" Racsnis hajtókar /</b><br/>1/2" Ratchet Handle</p> <p><b>1/2" Csuklós közdarab /</b><br/>Universal Joint</p> <p><b>1/2" T hajtókar /</b><br/>1/2" Sliding T Handle Adapter</p> <p><b>1/2" Toldal hosszabbító kar /</b><br/>1/2" Extension Bar 125-250 mm</p> <p>10 - 11 - 12<br/>13 - 14 - 15<br/>16 - 17 - 18<br/>19 - 21 - 22<br/>23 - 24 - 26<br/>27 - 28 - 30 - 32</p> | 24 |
| 1507        | <p><b>1/4" adapter /</b><br/>Spindle Handle</p>   | 1  |
| 4900        | <p><b>1/4" adapter /</b><br/>Hex Key Wrench Set<br/>2-2.5-3-3.5-4-5-6-7-8-9-10-12 mm</p>  | 12 |
| 4910        | <p><b>8 darabos Torx csavarhúzó készlet /</b><br/>Torx Key Wrench<br/>T9-T10-T15-T20-T25-T27-T30-T40</p>  | 8  |
| 1108        | <p><b>1/2" hosszú dugókulcsok /</b><br/>Deep Socket Wrench 6 point<br/>10-13-16-17-18-19 mm</p>   | 6  |
| 1113        | <p><b>1/2" 16 mm dugókulcsok /</b><br/>Spark Plug Socket With Rubber</p>  | 1  |
| 2400        | <p><b>Vízpumpa fogó 240 mm /</b><br/>Waterpump Pliers, Universal</p>  | 1  |
| 2500        | <p><b>Patentfogó 250 mm /</b><br/>Universal Grip</p>  | 1  |



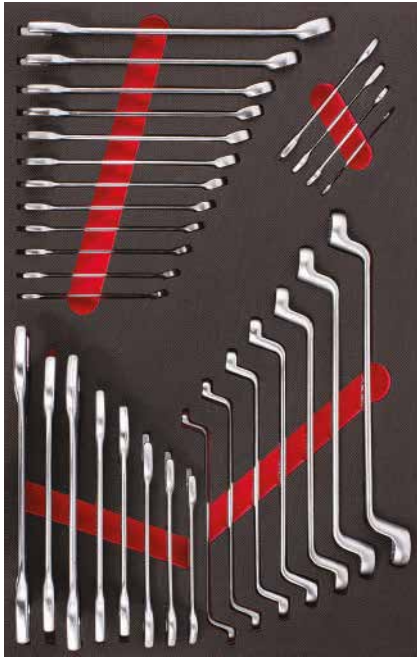

## 2. FIÓK / Drawer

KÓD / Code 8235002031

| KÓD<br>CODE | TARTALMA<br>CONTENTS  |    |
|-------------|---|----|
|             | <b>Villáskulcsok /</b><br>Double Ended Open Jaw Wrench Short Pattern                        |    |
| 0100        | 6x7 - 8x9 - 10x11 - 12x13<br>14x15 - 16x17 - 18x19 - 20x22<br>21x23 - 24x26 - 25x28 - 30x32 | 12 |
|             | <b>Csillag villáskulcsok /</b><br>Combination Wrench Short Pattern                          |    |
| 0320        | 8 - 9 - 10 - 11 - 12 - 13<br>14 - 15 - 16 - 17 - 19 - 22                                    | 12 |
|             | <b>Csillag kulcsok /</b><br>Ring Wrench   |    |
| 0430        | 8x9 - 10x11 - 12x13 - 14x15 - 16x17<br>18x19 - 20x22  | 7  |



## 3. FIÓK / Drawer

KÓD / Code 8235003017

| KÓD<br>CODE | TARTALMA<br>CONTENTS  |   |
|-------------|---|---|
| 4300        | <b>Csavarhúzó lapos /</b> Opak Screwdriver, Flat<br>3x80-4x80-4x100-5x125-6x150 | 5 |
| 4320        | <b>Csavarhúzó, kereszt Ph /</b> Opak Screwdriver, Philips<br>4.5x80-6x100       | 2 |
| 3700        | <b>Oldalvágó fogó 160 mm /</b> Side Cutting Pliers, 160 mm                      | 1 |
| 3020        | <b>Kombinált fogó /</b> Combination Pliers, 180 mm                              | 1 |
| 3220        | <b>Csőrfogó /</b> Nose Pliers, 200 mm   | 1 |
| 4770        | <b>Behajtó 6-7-8-9-10-13 /</b><br>Nutspinner 6-7-8-9-10-13                      | 5 |
| 5500        | <b>Hidegvágó, lapos 150 mm /</b> Flat Cold Chisel 150 mm                        | 1 |
| 5800        | <b>Kalapács 300 gr /</b> Mechanist Hammer 300 gr                                | 1 |



## Trend Széria műhely kocsi ( 5-7 fiókos )

### Trend Series Workshop Trolley ( 5-7 Drawers )



✓ Ellenálló és masszív fedőlap 4 osztással  
● Resistant and solid top cover with 4 divisions



✓ 100%-ban kihúzható teleszkópos sínek  
● 100% extendable telescopic slides

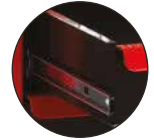

✓ Központi zárrendszer  
● Central locking



✓ 2 fékes forgókerékkel  
2 fix görgő  
● 2 swivel castors with brake  
2 fixed castors ø 100 mm



✓ Magas szilárdságú elektrosztatikus porfestés  
● High strength electrostatic powder coating



✓ Műanyag zár önnyitást megakadályozó funkcióval  
● Plastic lock preventing self opening



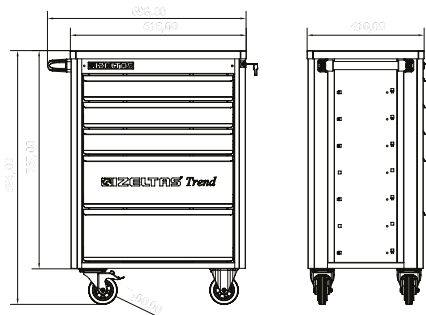

Méret/Size: 410x618x894 mm



IZELTAS YOUTUBE

Fémről készült,  
elektrosztatikus festéssel bevont  
Made of sheet metal, Electrostatic paint

| KÓD<br>CODE                              | Fiókok<br>DRAWERS |  25 kg |  25 kg |  Kg | Színek<br>COLORS |
|--|-------------------|---|---|--|------------------|
| 8244 32 1005                             | 5                 | 3X  | 2X  | 43   |                  |
| 8244 32 1007                             | 7                 | 7X  | --  | 43   |                  |
| 8244 00 5096<br>Teljes/Full<br>93 db/Pcs | 5                 | 3X  | 2X  |  |                  |

RAL 9005  
RAL 3020

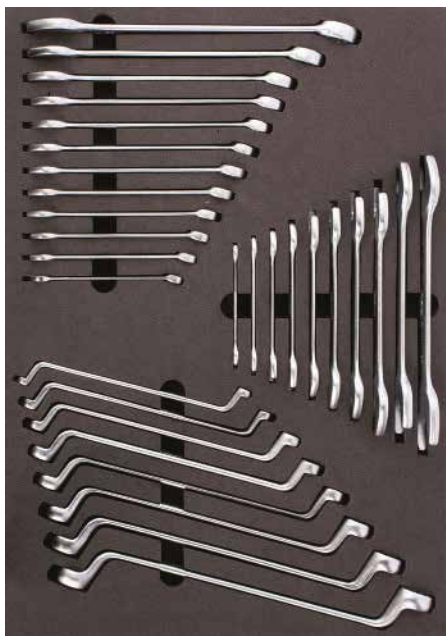
**1. FIÓK / Drawer**
**KÓD / Code 8244001030**

| KÓD<br>CODE | TARTALMA<br>CONTENTS   |    |  |
|-------------|--|----|--|
| 0100        | <b>Villáskulcsok /</b><br>Double Ended Open Jaw Wrench Short Pattern<br>6x7 - 8x9 - 10x11 - 12x13<br>14x15 - 16x17 - 18x19 - 20x22 - 21x23 - 24x26 | 10 |  |
| 0320        | <b>Csillag villáskulcsok /</b><br>Combination Wrench Short Pattern<br>8 - 9 - 10 - 11 - 12 - 13 - 14 - 15 - 16 - 17 - 19 - 22                      | 12 |  |
| 0430        | <b>Csillag kulcsok /</b><br>Ring Wrench<br>6x7 - 8x9 - 10x11 - 12x13 - 14x15 - 16x17<br>18x19 - 20x22  | 8  |  |

**2. FIÓK / Drawer**
**KÓD / Code 8244002052**

| KÓD<br>CODE | TARTALMA<br>CONTENTS  |    |  |
|-------------|---|----|--|
| 1113        | <b>1/2" Dugókulcs készlet /</b><br>1/2" Impact Socket Wrench<br>10 - 11 - 12 - 13 - 14 - 15 - 17 - 19<br>22 - 24 - 27 - 30 - 32<br>250 - 250 - 70 | 17 |  |
| 1107        | <b>1/4" dugókulcs készlet</b><br>/ 1/4" Socket Wrench Set<br>4 - 5 - 6 - 7 - 8 - 9 - 10 - 11 - 12 - 13<br>140 - 115 - 100 - 50 - 38               | 15 |  |
| 4900        | <b>Imbusz kulcskészlet /</b><br>Hex Key Wrench Set<br>2 - 2.5 - 3 - 3.5 - 4 - 5 - 6 - 7 - 8 - 9 - 10 - 12   | 12 |  |
| 4770        | <b>Behajtó 6-7-8-9-10-13 /</b><br>Nutspinner 6-7-8-9-10-13<br>6 - 7 - 8 - 10 - 13   | 5  |  |

**3. FIÓK / Drawer**
**KÓD / Code 8244003013**

| KÓD<br>CODE | TARTALMA<br>CONTENTS  |   |  |
|-------------|---|---|--|
| 4320        | <b>Csavarhúzó, kereszt Ph /Opak Screwdriver, Philips</b><br>4.5x80-6x100    | 2 |  |
| 4300        | <b>Csavarhúzó lapos / Opak Screwdriver, Flat</b><br>4x100-5x125-6x150-8x175 | 4 |  |
| 3700        | <b>Oldalvágó fogó 160 mm / Side Cutting Pliers, 160 mm</b>                  | 1 |  |
| 3020        | <b>Kombinált fogó / Combination Pliers, 180 mm</b>                          | 1 |  |
| 3220        | <b>Csőrősfogó / Nose Pliers, 200 mm</b>                                     | 1 |  |
| 5500        | <b>Hidegvágó, lapos 150 mm / Flat Cold Chisel 150 mm</b>                    | 1 |  |
| 5800        | <b>Kalapács 300 gr / Mechanist Hammer 300 gr</b>                            | 1 |  |
| 2510        | <b>Patent fogó / Special Grip 250 mm</b>                                    | 1 |  |
| 2400        | <b>Vízpumpafogó / Waterpump Pliers Universal 240 mm</b>                     | 1 |  |





## Szerszámoszláda (3 rekesz)

### Tool Box (3 Trays)

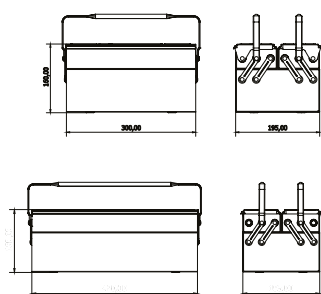

Fémlemezről készült, elektrosztatikus festéssel  
Made from metal sheet, Electrostatic paint

| KÓD<br>CODE  | Méret (mm)<br>Size | g    | □ |
|--------------|--------------------|------|---|
| 8410 33 6103 | 195x300x160        | 2400 | 1 |
| 8410 33 6203 | 195x420x160        | 3000 | 1 |

## Szerszámoszláda (5 rekesz)

### Tool Box (5 Trays)

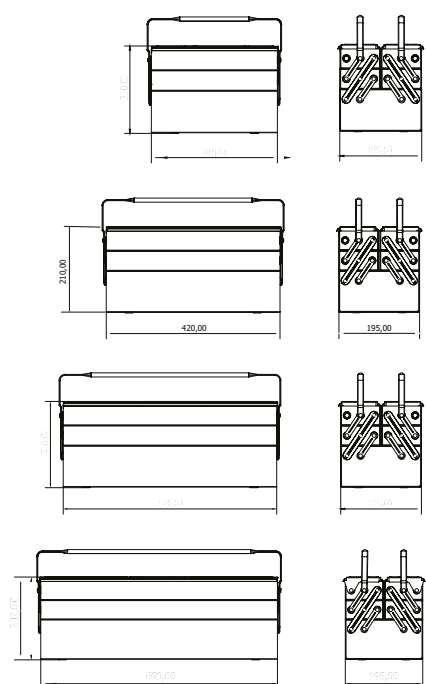
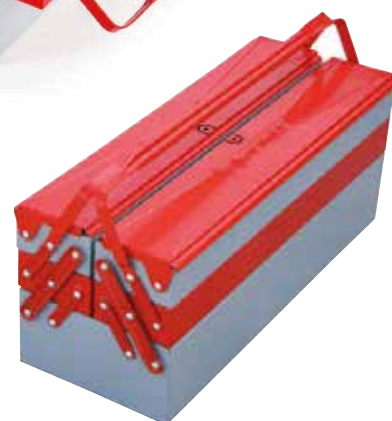

Fémlemezről készült, elektrosztatikus festéssel  
Made from metal sheet, Electrostatic paint

| KÓD<br>CODE  | Méret (mm)<br>Size | g    | □ |
|--------------|--------------------|------|---|
| 8420 33 6105 | 195x300x210        | 3200 | 1 |
| 8420 33 6205 | 195x420x210        | 4200 | 1 |
| 8420 33 6305 | 195x520x210        | 5000 | 1 |
| 8420 33 6405 | 195x600x210        | 5600 | 1 |

## Szerszámoszláda (5 rekesz)

Tool Box (5 Trays)



### 8420 00 5063

Szerszámoszláda szerelőknek  
(62 db, 5 rekesz)

Tool Box for Mechanician (62 Pcs, 5 Trays)



### 8420 00 5046

Szerszámoszláda villanszerelőknek  
(45 db, 5 rekesz)

Tool Box for Electrician (45 Pcs, 5 Trays)



### 8420 00 5028

Szerszámoszláda vízvezeték-szerelőknek  
(28 db, 5 rekesz)

Tool Box for Plumbers (28 Pcs, 5 Trays)



**8420 00 5063****Szerszámoszláda szerelőknak  
(62 db, 5 rekesz)**

Tool Box for Mechanician (62 Pcs, 5 Trays)

| KÓD<br>CODE | Méret<br>SIZE<br>mm |  |
|-------------|---------------------|--|
|-------------|---------------------|--|

8420 00 5063 195x420x210  
DOLU/FULL 62

| KÓD<br>CODE | KULCSOK<br>CONTENTS |  |
|-------------|---------------------|--|
|-------------|---------------------|--|

05881 50 015 Fém borítású mérőszalag /  
Chrom Case Steel,  
Measuring tapes 14785 19 6330 Csavarhúzó,  
mágneses bit tartóval  
Screwdriver, Magnetic  
Bit Holder (Short) 14800 00 8110 Bit Set 10 db 25 mm /  
Bits Set 10 (Pcs) 25 mm 104320 Csavarhúzó, lapos /  
Screwdriver, Opak, Flat  
4.5x80-6x100 24300 Csavarhúzó, kereszt Ph /  
Screwdriver, Opak, Phillips  
3x80-4x100-5x125-6x150 44550 17 0135 Fázisceruza  
Voltage Tester 12400 11 0240 Vízpumpa fogó, univerzális /  
Water Pump Pliers Universal 11113 1/2" Dugókulcs /  
Socket Wrench  
10-11-12-13-14-15-17  
19-22-24-27-30-32 131513 06 4250 Hosszabbító szár 250 mm /  
Extension Bar Long 250 mm 11513 06 4070 1/2"-os csuklós csatlakozó 70 mm /  
Universal Joint 70 mm 11513 06 0032 Racsnis hajtókar 250 mm /  
Ratchet Handle 250 mm 14900 00 3112 Imbuszkulcs készlet /  
Hex Key Wrench Set  
2-2.5-3-3.5-4-5-6-7-8-9-10-12 120320 Rövid szárú csillag villáskulcs-készlet/  
Short Pattern  
8-9-10-11-12-13  
14-17-19-22 103700 16 2160 Oldalvágó fogó /  
Side Cutting Nippers 13020 12 2180 Kombinált fogó, 180 mm /  
Combination Pliers 13220 13 2160 Hosszú csőrősfogó, lapos /  
Nose Pliers,  
Flat, Opak Insulated 1**8420 00 5046****Szerszámoszláda villanszerelőknak  
(45 db, 5 rekesz)**

Tool Box for Electrician (45 Pcs, 5 Trays)

| KÓD<br>CODE | Méret<br>SIZE<br>mm |  |
|-------------|---------------------|--|
|-------------|---------------------|--|

8420 00 5046 195x420x210  
Teljes / FULL 45

| KÓD<br>CODE | KULCSOK<br>CONTENTS |  |
|-------------|---------------------|--|
|-------------|---------------------|--|

05881 50 005 Plasztik borítású mérőszalag /  
Plastic Measuring Tape 14783 19 6120 Csavarhúzó,  
mágneses bit tartóval, szigetelt /  
Screwdriver, Magnetic  
Bit Holder Insulated  
6.3x120 14800 00 8106 Bit készlet (6 db)  
Bits Set (6 Pcs) 60600 01 1010 Állítható csavarkulcs  
Adjustable Jaw Wrench 14140-4145 Szigetelt, lapos csavarhúzó, Ph 1000 V  
Insulated Electrician type Flat  
Screwdriver, Phillis 1000V  
4x100-5.5x125 - 4.5x80-6x100 44550 17 0135 Fázisceruza, 135 mm /  
Voltage Tester 14550 17 0190 Fázisceruza, 190 mm /  
Voltage Tester 14773 Anya csavarkulcs, 1000 V /  
Nut Spinner, Electrician Blade  
Insulated 1000V  
6-7-8-10-13 50340 Racsnis csillag villáskulcs /  
Combination Wrench  
With Ratchet  
8-10-12-13-17-19 64900 00 3110 Imbuszkulcs készlet 10 db /  
Hex Key Wrench Set 10 pcs  
2-2.5-3-4-5-6-7-8-9-10 104500-4520 Elektromos csavarhúzó /  
Screwdriver, Electronic  
3x80-3x100-3x125-3x60-4x80 53700 16 6160 Szigetelt oldalvágó 1000 V /  
Insulated Electrician Type  
Side Cutter 1000V 13020 12 6180 Szigetelt kombinált fogó 1000 V /  
Insulated Electrician Type  
Combination Plier 1000V 13220 13 6160 Szigetelt csőrősfogó 1000 V /  
Insulated Electrician Type  
Nose Plier 1000V 1**8420 00 5028****Szerszámoszláda vízvezeték-szerelőknak  
(28 db, 5 rekesz)**

Tool Box for Plumbers (28 Pcs, 5 Trays)

| KÓD<br>CODE | Méret<br>SIZE<br>mm |  |
|-------------|---------------------|--|
|-------------|---------------------|--|

8420 00 5028 195x420x210  
Teljes / FULL 28

| KÓD<br>CODE | KULCSOK<br>CONTENTS |  |
|-------------|---------------------|--|
|-------------|---------------------|--|

0600 01 1010 Állítható csavarkulcs /  
10" Adjustable Wrench 10600 01 1012 Állítható csavarkulcs /  
12" Adjustable Jaw Wrench  
PVC Insulated 12400 11 0240 Vízpumpa fogó, univerzális /  
240 Waterpump Pliers,  
Universal 12100 10 0012 12" Csőkulcs, Stillson /  
12" Pipe Wrench, Stillson 14901 22 1270 1/2" Imbuszkulcs /  
1/2" Hex Key Wrench SAE 14300 17 6150 Csavarhúzó, lapos /  
Screwdriver, Opak, Slotted  
6x150 14320 18 6100 Csavarhúzó, Phillips /  
Screwdriver, Opak, Phillips  
6x100 15800 25 0500 Kalapács /  
Machinist Hammer 15500 23 0200 Hidegvágó /  
Flat Cold Chisel 13830 15 0250 Harapó-fogó /  
Tower Pincers 14900 00 3112 Hatlap imbusz kulcskészlet 10 db /  
Hex Key Wrench Set 12 pcs  
2-2.5-3-3.5-4-5-6-7-8-9-10-12 120588 15 0015 Krómozott borítású  
acél mérőszalag /  
Chrom Case Steel Measuring Tape 12201 10 0010 1" csőkulcs /  
1" Pipe Wrench 13700 16 2160 Oldalvágó fogó /  
Side Cutting Nippers, Opak  
insulated 13020 12 2180 Kombinált fogó /  
Combination Pliers, Opak  
Insulated 13220 13 2160 Csőrősfogó, lapos /  
Nose Pliers, Flat, Opak  
Insulated 1



## Rövid szárú, csillag-villás kulcs, metrikus (mm)

Combination Wrench Short Pattern (mm)

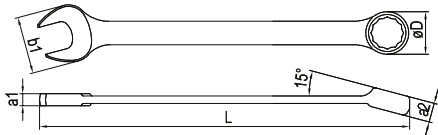
TS 3794  
TS ISO 7738 Form A  
DIN 3113Krómozott felületű, króm-vanádium  
Chrom vanadium, Chrom plated

| KÓD<br>CODE  | mm  | L<br>mm | a1<br>mm | a2<br>mm | b1<br>mm | øD<br>mm | g   |    |
|--------------|-----|---------|----------|----------|----------|----------|-----|----|
| 0320 02 0005 | 5   | 90      | 3.4      | 5.1      | 14       | 10       | 15  | 10 |
| 0320 02 0055 | 5.5 | 90      | 3.4      | 5.1      | 14       | 10       | 15  | 10 |
| 0320 02 0006 | 6   | 100     | 3.4      | 5.1      | 14       | 10       | 15  | 10 |
| 0320 02 0007 | 7   | 110     | 3.6      | 5.5      | 16       | 11       | 20  | 10 |
| 0320 02 0008 | 8   | 120     | 3.8      | 5.9      | 18       | 13       | 25  | 10 |
| 0320 02 0009 | 9   | 130     | 4        | 6.3      | 20       | 14       | 30  | 10 |
| 0320 02 0010 | 10  | 140     | 4.3      | 6.9      | 22       | 15.5     | 40  | 10 |
| 0320 02 0011 | 11  | 150     | 4.5      | 7.3      | 24       | 17       | 45  | 10 |
| 0320 02 0012 | 12  | 160     | 4.9      | 7.7      | 26       | 18.5     | 55  | 10 |
| 0320 02 0013 | 13  | 170     | 5.2      | 7.9      | 28       | 19.5     | 60  | 10 |
| 0320 02 0014 | 14  | 180     | 5.5      | 8.7      | 30       | 21.5     | 75  | 10 |
| 0320 02 0015 | 15  | 190     | 5.8      | 9.1      | 32       | 22.5     | 90  | 10 |
| 0320 02 0016 | 16  | 200     | 6.1      | 9.6      | 34       | 24       | 105 | 10 |
| 0320 02 0017 | 17  | 210     | 6.4      | 9.8      | 36       | 25.5     | 120 | 10 |
| 0320 02 0018 | 18  | 220     | 6.8      | 10.4     | 38       | 27       | 145 | 10 |
| 0320 02 0019 | 19  | 232     | 7        | 11       | 40       | 28.5     | 170 | 10 |
| 0320 02 0020 | 20  | 240     | 7.2      | 11.4     | 42       | 30       | 195 | 10 |
| 0320 02 0021 | 21  | 250     | 7.4      | 12       | 44       | 31.5     | 190 | 10 |
| 0320 02 0022 | 22  | 260     | 8.2      | 12.6     | 46       | 33       | 275 | 10 |
| 0320 02 0023 | 23  | 270     | 8.3      | 13       | 48       | 35       | 255 | 5  |
| 0320 02 0024 | 24  | 280     | 8.5      | 13.6     | 50       | 36.5     | 320 | 5  |
| 0320 02 0025 | 25  | 290     | 8.8      | 14       | 52       | 39       | 320 | 5  |
| 0320 02 0026 | 26  | 300     | 9        | 14.8     | 54       | 41       | 400 | 5  |
| 0320 02 0027 | 27  | 310     | 9.3      | 15       | 56       | 41.5     | 400 | 5  |
| 0320 02 0028 | 28  | 320     | 9.4      | 15.4     | 47.5     | 42.5     | 380 | 5  |
| 0320 02 0029 | 29  | 330     | 10       | 15.6     | 59       | 43.5     | 510 | 5  |
| 0320 02 0030 | 30  | 340     | 10.3     | 16       | 61.5     | 44       | 505 | 5  |
| 0320 02 0032 | 32  | 370     | 10.5     | 16.2     | 65.5     | 47       | 560 | 5  |
| 0320 02 0034 | 34  | 400     | 10.7     | 16.8     | 71       | 50       | 675 | 5  |

## 0320

Rövid szárú, csillag-villás kulcskészlet,  
metrikus

Combination Wrench Short Pattern Set (mm)



| KÓD<br>CODE  | KULCSOK<br>CONTENTS  | g    |    |
|--------------|--|------|----|
| 0320 00 2108 | 6 - 7 - 8 - 9 - 10 - 13 - 17 - 19  | 475  | 8  |
| 0320 00 2112 | 8 - 9 - 10 - 11 - 12 - 13 - 14<br>15 - 16 - 17 - 19 - 22   | 1190 | 12 |
| 0320 00 2117 | 6 - 7 - 8 - 9 - 10 - 11 - 12 - 13 - 14<br>15 - 16 - 17 - 18 - 19 - 20 - 21 - 22                      | 1760 | 17 |
| 0320 00 2121 | 6 - 7 - 8 - 9 - 10 - 11 - 12 - 13 - 14<br>15 - 16 - 17 - 18 - 19 - 20 - 21 - 22<br>24 - 27 - 30 - 32 | 3650 | 21 |

## Hosszú szárú, csillag-villás kulcs, metrikus (mm)

Combination Wrench, Long Pattern (mm)

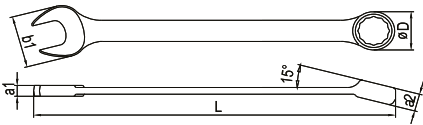
TS 3794  
TS ISO 7738 Form A  
DIN 3113

Krómozott felületű, króm-vanádium

Chrom vanadium, Chrom plated

| KÓD<br>CODE  | mm  | L<br>mm | a1<br>mm | a2<br>mm | b1<br>mm | øD<br>mm | g    |    |
|--------------|-----|---------|----------|----------|----------|----------|------|----|
| 0330 02 0005 | 5   | 95      | 3.2      | 5.2      | 12.5     | 9        | 20   | 10 |
| 0330 02 0055 | 5.5 | 95      | 3.2      | 5.2      | 12.5     | 9        | 20   | 10 |
| 0330 02 0006 | 6   | 105     | 3.8      | 5.6      | 14       | 10.5     | 20   | 10 |
| 0330 02 0007 | 7   | 117     | 4        | 6.1      | 16       | 12       | 20   | 10 |
| 0330 02 0008 | 8   | 130     | 4.2      | 6.6      | 18       | 13.5     | 30   | 10 |
| 0330 02 0009 | 9   | 141     | 4.5      | 7        | 20       | 15       | 40   | 10 |
| 0330 02 0010 | 10  | 154     | 4.7      | 7.6      | 22       | 16       | 50   | 10 |
| 0330 02 0011 | 11  | 166     | 5        | 8.2      | 24       | 17.5     | 60   | 10 |
| 0330 02 0012 | 12  | 178     | 5.2      | 8.7      | 26       | 19       | 70   | 10 |
| 0330 02 0013 | 13  | 190     | 5.6      | 9.2      | 28       | 20.5     | 80   | 10 |
| 0330 02 0014 | 14  | 203     | 5.8      | 9.7      | 30       | 22       | 100  | 10 |
| 0330 02 0015 | 15  | 215     | 6.4      | 10.1     | 32       | 23.5     | 115  | 10 |
| 0330 02 0016 | 16  | 227     | 6.4      | 10.8     | 34       | 25       | 135  | 10 |
| 0330 02 0017 | 17  | 239     | 6.6      | 11.4     | 36       | 26.5     | 160  | 10 |
| 0330 02 0018 | 18  | 250     | 7        | 12       | 38       | 28       | 186  | 10 |
| 0330 02 0019 | 19  | 263     | 7.3      | 12.7     | 40       | 29.5     | 205  | 10 |
| 0330 02 0020 | 20  | 275     | 7.7      | 13.2     | 42       | 31       | 235  | 10 |
| 0330 02 0021 | 21  | 288     | 8.1      | 13.3     | 44       | 31.5     | 260  | 10 |
| 0330 02 0022 | 22  | 300     | 8.5      | 13.7     | 46       | 34       | 300  | 10 |
| 0330 02 0023 | 23  | 315     | 8.8      | 14.2     | 48       | 35.5     | 300  | 5  |
| 0330 02 0024 | 24  | 330     | 9        | 14.2     | 50       | 37       | 390  | 5  |
| 0330 02 0025 | 25  | 340     | 9.3      | 14.7     | 52       | 38.5     | 380  | 5  |
| 0330 02 0026 | 26  | 350     | 9.7      | 14.7     | 54       | 40       | 475  | 5  |
| 0330 02 0027 | 27  | 360     | 10       | 15.2     | 56       | 41       | 475  | 5  |
| 0330 02 0028 | 28  | 370     | 10.4     | 15.7     | 57.5     | 43       | 475  | 5  |
| 0330 02 0029 | 29  | 390     | 10.8     | 16.2     | 59       | 44       | 610  | 5  |
| 0330 02 0030 | 30  | 410     | 11.2     | 16.6     | 61.5     | 45       | 610  | 5  |
| 0330 02 0032 | 32  | 420     | 11.5     | 17.1     | 65.5     | 48       | 755  | 5  |
| 0330 02 0034 | 34  | 430     | 11.8     | 17.4     | 71       | 50.5     | 735  | 5  |
| 0330 02 0036 | 36  | 440     | 12.2     | 17.7     | 76       | 53       | 1000 | 5  |
| 0330 02 0038 | 38  | 450     | 12.5     | 18.7     | 80       | 56       | 1000 | 5  |
| 0330 02 0041 | 41  | 480     | 13.5     | 19.7     | 87       | 61       | 1240 | 5  |
| 0330 02 0046 | 46  | 505     | 14.7     | 20.7     | 95       | 67.5     | 1635 | 1  |
| 0330 02 0050 | 50  | 540     | 15.9     | 22.7     | 104      | 73.5     | 2100 | 1  |

## 0330

## Hosszú szárú, csillag-villás kulcskészlet, metrikus

Combination Wrench Long Pattern Set (mm)



| KÓD<br>CODE  | KULCSOK<br>CONTENTS   | g    |    |
|--------------|---|------|----|
| 0330 00 2108 | 6 - 7 - 8 - 9 - 10 - 13<br>17 - 19  | 665  | 8  |
| 0330 00 2112 | 8 - 9 - 10 - 11 - 12<br>13 - 14 - 15 - 16<br>17 - 19 - 22   | 1780 | 12 |
| 0330 00 2117 | 6 - 7 - 8 - 9 - 10<br>11 - 12 - 13 - 14 - 15<br>16 - 17 - 18 - 19<br>20 - 21 - 22                     | 2170 | 17 |
| 0330 00 2121 | 6 - 7 - 8 - 9 - 10 - 11<br>12 - 13 - 14 - 15 - 16<br>17 - 18 - 19 - 20 - 21<br>22 - 24 - 27 - 30 - 32 | 4465 | 21 |

## Racsnis csillag-villás kulcs, metrikus

### Combination Wrench With Ratchet (mm)

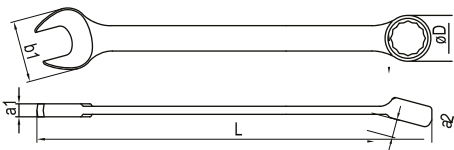

**Krómozott felületű, króm-vanádium**  
Chrom vanadium, Chrom plated

| KÓD<br>CODE  | mm | L<br>mm | a1<br>mm | a2<br>mm | b1<br>mm | øD<br>mm | g   |    |
|--------------|----|---------|----------|----------|----------|----------|-----|----|
| 0340 02 0008 | 8  | 140     | 4.9      | 6.4      | 16.9     | 17.1     | 35  | 10 |
| 0340 02 0009 | 9  | 149     | 5        | 6.7      | 19.7     | 19.1     | 40  | 10 |
| 0340 02 0010 | 10 | 159     | 5        | 7        | 21.1     | 20.3     | 55  | 10 |
| 0340 02 0011 | 11 | 165     | 5.3      | 7.3      | 24       | 22.5     | 70  | 10 |
| 0340 02 0012 | 12 | 171     | 5.6      | 7.6      | 26.5     | 23.5     | 80  | 10 |
| 0340 02 0013 | 13 | 178     | 5.9      | 8.1      | 27.7     | 25.3     | 90  | 10 |
| 0340 02 0014 | 14 | 190     | 6.3      | 8.5      | 30.7     | 27.5     | 120 | 10 |
| 0340 02 0015 | 15 | 199     | 6.7      | 9        | 32       | 28.8     | 135 | 10 |
| 0340 02 0016 | 16 | 208     | 6.7      | 9.5      | 34       | 30.3     | 155 | 10 |
| 0340 02 0017 | 17 | 225     | 7        | 10       | 36.2     | 32.2     | 190 | 10 |
| 0340 02 0018 | 18 | 236     | 7.7      | 10.5     | 38.2     | 33.3     | 200 | 10 |
| 0340 02 0019 | 19 | 248     | 8.3      | 11       | 40.4     | 35       | 240 | 10 |
| 0340 02 0021 | 21 | 288     | 9.4      | 13       | 45.7     | 40.7     | 350 | 10 |
| 0340 02 0022 | 22 | 288     | 9.4      | 13       | 45.7     | 40.7     | 340 | 10 |
| 0340 02 0024 | 24 | 321     | 10.5     | 14.5     | 52       | 46.2     | 470 | 5  |

## 0340

## Racsnis csillag-villás kulcskészlet, metrikus

Combination Wrench With Ratchet, Set (mm)



## 0335

## Racsnis csillagkulcs, metrikus (mm)

### Multi-Ring Wrench (mm)



**Krómozott felületű, króm-vanádium**  
Chrom vanadium, Chrom plated

| KÓD<br>CODE  | KULCSOK<br>CONTENTS   | g    |    |
|--------------|---|------|----|
| 0340 00 2110 | 8 - 9 - 10 - 11<br>12 - 13 - 14 - 15 - 17 - 19                            | 1315 | 10 |
| 0340 00 2115 | 8 - 9 - 10 - 11 - 12 - 13 - 14 - 15 - 16 - 17 - 18<br>- 19 - 21 - 22 - 24 | 2445 | 15 |

| KÓD<br>CODE  | Méret<br>SIZE | L<br>mm | g   |   |
|--------------|---------------|---------|-----|---|
| 0335 02 0010 | 10x13x17x19   | 230     | 215 | 5 |

## Hajlított szárú csillagkulcs, metrikus

Double Ended Ring Wrench (mm)

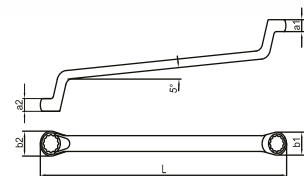
TS 3794  
TS ISO 10104 Form B  
DIN 838

Krómozott felületű, króm-vanádium

Chrom vanadium, Chrom plated

| KÓD<br>CODE  | mm    | L<br>mm | a1<br>mm | a2<br>mm | b1<br>mm | b2<br>mm | g    |    |
|--------------|-------|---------|----------|----------|----------|----------|------|----|
| 0430 03 0607 | 6x7   | 176     | 5.6      | 6        | 10       | 11.5     | 55   | 10 |
| 0430 03 0809 | 8x9   | 190     | 6.4      | 6.8      | 13       | 14.5     | 75   | 10 |
| 0430 03 0810 | 8x10  | 190     | 6.4      | 7.3      | 13       | 15.5     | 70   | 10 |
| 0430 03 1011 | 10x11 | 206     | 7.3      | 7.6      | 15.5     | 17       | 105  | 10 |
| 0430 03 1012 | 10x12 | 206     | 7.3      | 8.5      | 15.5     | 18.5     | 105  | 10 |
| 0430 03 1013 | 10x13 | 220     | 7.3      | 9        | 15.5     | 20       | 120  | 10 |
| 0430 03 1113 | 11x13 | 220     | 8.5      | 9        | 18.5     | 20       | 130  | 10 |
| 0430 03 1213 | 12x13 | 220     | 8.5      | 9        | 18.5     | 20       | 135  | 10 |
| 0430 03 1214 | 12x14 | 220     | 8.5      | 9.5      | 18.5     | 23       | 145  | 10 |
| 0430 03 1415 | 14x15 | 236     | 9.5      | 10       | 21.5     | 23       | 180  | 10 |
| 0430 03 1317 | 13x17 | 250     | 9        | 11.5     | 20       | 26.5     | 215  | 10 |
| 0430 03 1417 | 14x17 | 250     | 9.5      | 11.5     | 21.5     | 26.5     | 210  | 10 |
| 0430 03 1617 | 16x17 | 250     | 10.8     | 11.5     | 25       | 26.5     | 220  | 10 |
| 0430 03 1618 | 16x18 | 260     | 10.8     | 12       | 25       | 27.5     | 210  | 10 |
| 0430 03 1719 | 17x19 | 271     | 11.5     | 12.5     | 26.5     | 29       | 270  | 10 |
| 0430 03 1819 | 18x19 | 271     | 12       | 12.5     | 27.5     | 29       | 270  | 10 |
| 0430 03 1922 | 19x22 | 291     | 12.5     | 13.5     | 29       | 33       | 330  | 5  |
| 0430 03 1924 | 19x24 | 311     | 12.5     | 14.2     | 29       | 36.5     | 345  | 5  |
| 0430 03 2022 | 20x22 | 291     | 12.9     | 13.5     | 30.5     | 33       | 330  | 5  |
| 0430 03 2123 | 21x23 | 311     | 13.1     | 14       | 32       | 35       | 410  | 5  |
| 0430 03 2224 | 22x24 | 321     | 13.5     | 14.2     | 33       | 36.5     | 410  | 5  |
| 0430 03 2426 | 24x26 | 331     | 14.2     | 14.6     | 36.5     | 39.5     | 495  | 5  |
| 0430 03 2427 | 24x27 | 331     | 14.2     | 15       | 36.5     | 40.5     | 495  | 5  |
| 0430 03 2430 | 24x30 | 352     | 14.2     | 16.7     | 36.5     | 45       | 530  | 5  |
| 0430 03 2528 | 25x28 | 352     | 14.5     | 15.5     | 38       | 42.5     | 550  | 5  |
| 0430 03 2729 | 27x29 | 371     | 15       | 16.7     | 40.5     | 45       | 660  | 5  |
| 0430 03 2730 | 27x30 | 371     | 15       | 16.7     | 40.5     | 45       | 660  | 5  |
| 0430 03 2732 | 27x32 | 371     | 15       | 16.7     | 40.5     | 47.5     | 660  | 5  |
| 0430 03 3032 | 30x32 | 371     | 16.4     | 16.7     | 45       | 47.5     | 660  | 5  |
| 0430 03 3036 | 30x36 | 402     | 16.4     | 17.5     | 45       | 53       | 880  | 5  |
| 0430 03 3236 | 32x36 | 402     | 16.7     | 17.5     | 47.5     | 53       | 890  | 5  |
| 0430 03 3436 | 34x36 | 420     | 17.1     | 17.5     | 50       | 53       | 1000 | 5  |
| 0430 03 3641 | 36x41 | 438     | 17.5     | 19.5     | 53       | 61       | 1150 | 5  |
| 0430 03 4146 | 41x46 | 485     | 19.5     | 20.5     | 61       | 67.5     | 1430 | 5  |
| 0430 03 4650 | 46x50 | 535     | 20.5     | 22.4     | 67.5     | 73.5     | 1960 | 5  |

## SPECIÁLIS SZÉRIA (Érdeklődjön mennyiségi és szállítási feltételekért)

SPECIAL SERIES (ask for quantity and delivery terms)

|              |       |     |      |      |      |      |     |    |
|--------------|-------|-----|------|------|------|------|-----|----|
| 0430 03 1014 | 10x14 | 220 | 7.3  | 9    | 15.5 | 21.5 | 120 | 10 |
| 0430 03 1315 | 13x15 | 236 | 9    | 10   | 20   | 23   | 170 | 10 |
| 0430 03 2227 | 22x27 | 331 | 14.2 | 15   | 36.5 | 40.5 | 500 | 5  |
| 0430 03 3034 | 30x34 | 379 | 16.4 | 16.9 | 45   | 50   | 690 | 5  |

## 0430

## Hajlított szárú csillagkulcs-készlet, metrikus

Double Ended Ring Wrench Set (mm)



| KÓD<br>CODE  | KULCSOK<br>CONTENTS   | g    |    |
|--------------|---|------|----|
| 0430 00 2108 | 6x7 - 8x9 - 10x11 - 12x13 - 14x15 16x17 -<br>18x19 - 20x22                                  | 1450 | 8  |
| 0430 00 2112 | 6x7 - 8x9 - 10x11 - 12x13 - 14x15 16x17 -<br>18x19 - 20x22 - 21x23<br>24x26 - 25x28 - 27x32 | 3610 | 12 |



## Hajlított önindító kulcs, metrikus

Double - Hex Starter and Block Wrench (mm)

TSEK

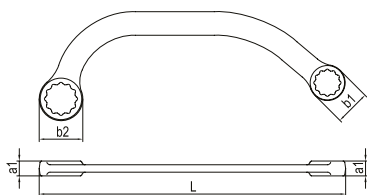

| KÓD<br>CODE  | mm    | L<br>mm | a1<br>mm | b1<br>mm | b2<br>mm | g   |    |
|--------------|-------|---------|----------|----------|----------|-----|----|
| 0530 04 0810 | 8x10  | 120     | 6        | 12.5     | 15.5     | 30  | 10 |
| 0530 04 1011 | 10x11 | 150     | 7        | 17       | 20       | 55  | 10 |
| 0530 04 1012 | 10x12 | 150     | 7        | 17       | 20       | 55  | 10 |
| 0530 04 1113 | 11x13 | 150     | 7        | 17       | 20       | 55  | 10 |
| 0530 04 1315 | 13x15 | 185     | 9        | 21.5     | 26       | 110 | 10 |
| 0530 04 1317 | 13x17 | 185     | 9        | 21.5     | 26       | 105 | 10 |
| 0530 04 1417 | 14x17 | 185     | 9        | 21.5     | 26       | 110 | 10 |
| 0530 04 1517 | 15x17 | 185     | 9        | 21.5     | 26       | 100 | 10 |
| 0530 04 1922 | 19x22 | 230     | 11       | 29       | 33       | 195 | 10 |

Krómozott felületű, króm-vanádium

Chrom vanadium, Chrom plated

## Fékcső kulcs, metrikus

Flare Nut Wrench (mm)

DIN 3118



| KÓD<br>CODE  | mm    | L<br>mm | a1<br>mm | a2<br>mm | b1<br>mm | b2<br>mm | g   |    |
|--------------|-------|---------|----------|----------|----------|----------|-----|----|
| 0540 01 0810 | 8x10  | 130     | 7        | 8.5      | 18       | 20       | 60  | 10 |
| 0540 01 1011 | 10x11 | 150     | 8.5      | 9.3      | 20       | 22       | 75  | 10 |
| 0540 01 1012 | 10x12 | 150     | 8.5      | 9.3      | 20       | 22       | 75  | 10 |
| 0540 01 1113 | 11x13 | 170     | 9.3      | 10.8     | 22       | 25.5     | 105 | 10 |
| 0540 01 1214 | 12x14 | 170     | 9.3      | 10.8     | 22       | 25.5     | 105 | 10 |
| 0540 01 1719 | 17x19 | 210     | 11.8     | 13       | 30.5     | 33.5     | 185 | 10 |
| 0540 01 1922 | 19x22 | 230     | 12.8     | 14.9     | 33.5     | 39.5     | 235 | 10 |

Krómozott felületű, króm-vanádium

Chrom vanadium, Chrom plated

## 1/4"-os dugókulcs fej, 50 mm

### Deep Socket Wrench 6 Points (mm)

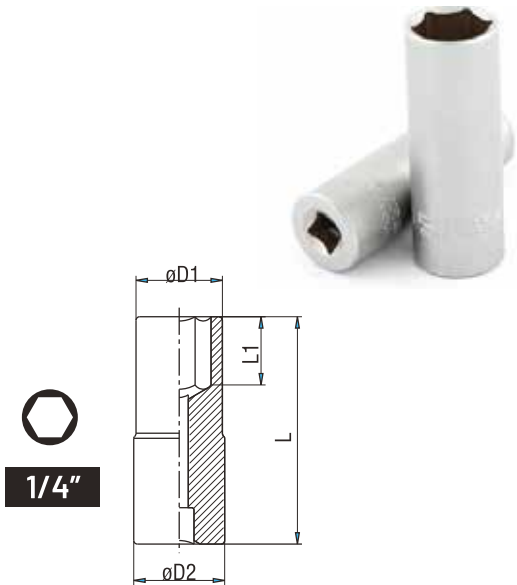

| KÓD<br>CODE  | mm  | σ D1<br>mm | σ D2<br>mm | L<br>mm | L1<br>mm | g  |    |
|--------------|-----|------------|------------|---------|----------|----|----|
| 1107 06 4004 | 4   | 6.8        | 11.8       | 50      | 6        | 10 | 10 |
| 1107 06 4005 | 5   | 8          | 11.8       | 50      | 7        | 20 | 10 |
| 1107 06 4055 | 5.5 | 8.7        | 11.8       | 50      | 9        | 20 | 10 |
| 1107 06 4006 | 6   | 9.2        | 11.8       | 50      | 9        | 25 | 10 |
| 1107 06 4007 | 7   | 10.8       | 11.8       | 50      | 15       | 25 | 10 |
| 1107 06 4008 | 8   | 11.8       | 11.8       | 50      | 15       | 25 | 10 |
| 1107 06 4009 | 9   | 13         | 13         | 50      | 15       | 30 | 10 |
| 1107 06 4010 | 10  | 14.5       | 14.5       | 50      | 15       | 40 | 10 |
| 1107 06 4011 | 11  | 15.8       | 15.8       | 50      | 21       | 45 | 10 |
| 1107 06 4012 | 12  | 16.8       | 16.8       | 50      | 21       | 50 | 10 |
| 1107 06 4013 | 13  | 17.8       | 17.8       | 50      | 21       | 55 | 10 |

**Krómozott, fényes felületű króm-vanádium**  
 Chrom vanadium, Chrom Plated, Polished

## 1/4"-os imbusz bitfej

Hexagonal Bit  
 Socket Wrench



| KÓD<br>CODE  | mm  | L<br>mm | g  |    |
|--------------|-----|---------|----|----|
| 1107 06 1125 | 2.5 | 37      | 13 | 10 |
| 1107 06 1103 | 3   | 37      | 13 | 10 |
| 1107 06 1104 | 4   | 37      | 15 | 10 |
| 1107 06 1105 | 5   | 37      | 15 | 10 |
| 1107 06 1106 | 6   | 37      | 15 | 10 |
| 1107 06 1107 | 7   | 37      | 16 | 10 |
| 1107 06 1108 | 8   | 37      | 17 | 10 |
| 1107 06 1110 | 10  | 37      | 19 | 10 |

**Króm-vanádium, krómozott**  
 Chrom vanadium, Chrom Plated

## 1/4"-os Torx bitfej

### Torx Bit Socket Wrench



| KÓD<br>CODE  |     | L<br>mm | g  |    |
|--------------|-----|---------|----|----|
| 1107 06 1208 | T8  | 37      | 12 | 10 |
| 1107 06 1209 | T9  | 37      | 12 | 10 |
| 1107 06 1210 | T10 | 37      | 13 | 10 |
| 1107 06 1215 | T15 | 37      | 14 | 10 |
| 1107 06 1220 | T20 | 37      | 14 | 10 |
| 1107 06 1225 | T25 | 37      | 14 | 10 |
| 1107 06 1227 | T27 | 37      | 14 | 10 |
| 1107 06 1230 | T30 | 37      | 15 | 10 |
| 1107 06 1240 | T40 | 37      | 16 | 10 |

**Ne használja elektromos kéziszerszámmal**  
 / Do not use with power-tools

**Króm-vanádium, krómozott**  
 Chrom vanadium, Chrom Plated

1107

**1/4"-os 15 részes dugókulcs készlet**Socket Wrench Set 6 Points  
(15 pcs, mm)

1/4"

| KÓD<br>CODE  | KULCSOK<br>Sockets                          | TARTOZÉKOK<br>Accessories                          | g   |    |
|--------------|---|--|-----|----|
| 1107 00 6015 |   | 1/4"-es racsnis hajtókar<br>Ratchet Handle         | 960 | 15 |
|              | 4 - 5 - 6<br>7 - 8 - 9 - 10<br>11 - 12 - 13 | 1/4"-es csuklós csatlakozó<br>Universal Joint      |     |    |
|              | Hatlapú<br>Six Points                       | 1/4"-es T hajtókar<br>Sliding T Handle             |     |    |
|              |   | 1/4"-es hosszabbító, 50 mm<br>Extension Bar 50 mm  |     |    |
|              |   | 1/4"-es hosszabbító 100 mm<br>Extension Bar 100 mm |     |    |

1107

**1/4" 14 db-os hosszított dugókulcs készlet**

Deep Socket Wrench Set Type 6 Points (14 pcs, mm)



1/4"

| KÓD<br>CODE  | KULCSOK<br>Sockets              | TARTOZÉKOK<br>Accessories                          | g    |    |
|--------------|---------------------------------|--|------|----|
| 1107 00 6014 |                                 | 1/4"-es racsnis hajtókar<br>Ratchet Handle         | 1005 | 14 |
|              | 4-5-5-6<br>7-8-9-10<br>11-12-13 | 1/4"-es hosszabbító, 50 mm<br>Extension Bar 50 mm  |      |    |
|              | Hatlapú<br>Six Points           | 1/4"-es hosszabbító 100 mm<br>Extension Bar 100 mm |      |    |
|              |                                 |  |      |    |
|              |                                 |  |      |    |

1107

**1/4"-os dugókulcs 25 mm**

Socket Wrench 6 Points (mm)

TS ISO 2725 -1  
DIN 3124

1/4"

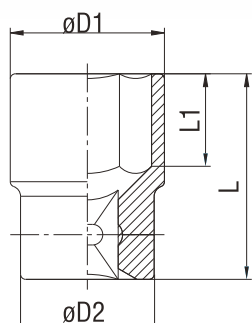

| KÓD<br>CODE  | mm  | ø D1<br>mm | ø D2<br>mm | L<br>mm | L1<br>mm | g  |    |
|--------------|-----|------------|------------|---------|----------|----|----|
| 1107 06 0004 | 4   | 6.8        | 11.8       | 25      | 4        | 10 | 10 |
| 1107 06 0045 | 4.5 | 7.4        | 11.8       | 25      | 5        | 10 | 10 |
| 1107 06 0005 | 5   | 8          | 11.8       | 25      | 6        | 10 | 10 |
| 1107 06 0055 | 5.5 | 8.5        | 11.8       | 25      | 6        | 10 | 10 |
| 1107 06 0006 | 6   | 9.2        | 11.8       | 25      | 7        | 10 | 10 |
| 1107 06 0007 | 7   | 10.8       | 11.8       | 25      | 7        | 10 | 10 |
| 1107 06 0008 | 8   | 11.9       | 11.8       | 25      | 8        | 10 | 10 |
| 1107 06 0009 | 9   | 12.9       | 12.8       | 25      | 8        | 15 | 10 |
| 1107 06 0010 | 10  | 14.3       | 14.3       | 25      | 9        | 20 | 10 |
| 1107 06 0011 | 11  | 15.8       | 15.8       | 25      | 9        | 20 | 10 |
| 1107 06 0012 | 12  | 16.8       | 16.8       | 25      | 9        | 25 | 10 |
| 1107 06 0013 | 13  | 17.8       | 17.8       | 25      | 9        | 30 | 10 |

**Krómozott, fényes felületű króm-vanádium**  
Chrom vanadium, Chrom plated, Polished

1507

### 1/4"-os hosszabbító szár Extension Bar

TS ISO 3316  
DIN 3123



1/4"

Krómozott fényes felületű  
króm vanádium  
Chrom vanadium, Chrom plated, Polished

| KÓD<br>CODE  | L<br>mm | g  |   |
|--------------|---------|----|---|
| 1507 06 0050 | 50      | 25 | 5 |
| 1507 06 0100 | 100     | 45 | 5 |

1507

### 1/4"-os csuklós csatlakozó Universal Joint

TS ISO 1174  
DIN 3123



1/4"

Krómozott fényes felületű  
króm-vanádium  
Chrom vanadium, Chrom plated, Polished

| KÓD<br>CODE  | L<br>mm | g  |   |
|--------------|---------|----|---|
| 1507 06 0038 | 38      | 25 | 5 |

1507

### Racsnis hajtókar Ratchet With Latch (24 Teeth)

TS ISO 3315



1/4"

Krómozott fényes felületű  
króm vanádium  
Chrom vanadium, Chrom plated, Polished

| KÓD<br>CODE  | L<br>mm | g   |   |
|--------------|---------|-----|---|
| 1507 06 6140 | 140     | 140 | 5 |



1108

## 1/2"-os hosszított dugókulcs készlet 10 db-os

Deep Socket Set (10 pcs. mm)



1/2"

| KÓD<br>CODE  | TARTALMA<br>CONTENTS             | g    |    |
|--------------|----------------------------------|------|----|
| 1108 00 6010 | 10-11-12-13-14-15<br>16-17-18-19 | 1290 | 10 |

Ne használja elektromos kéziszerszámmal  
/ Do not use with power-tools

1113

## 1/2"-os dugókulcsfej készlet, Torx 7 db-os

Star Torx® Socket Wrench Set (7 Pcs)



1/2"

| KÓD<br>CODE  | TARTALMA<br>CONTENTS   | g    |   |
|--------------|--|------|---|
| 1113 00 6007 | Csillagkulcs / Star Socket<br>E10 - E12 - E14 - E16 - E18 - E20<br>Hosszabbító / Extension Bar | 1075 | 7 |

1113

## Dugó kulcskészlet tárolóval (145 db)

Display Frame for Sockets (145 Pcs)



1/2"

| KÓD<br>CODE  | Tartalma<br>CONTENTS   | g      |   |
|--------------|--|--------|---|
| 1113 00 6145 | Teljes/Full<br>10-11-12-13-14-15-16-17-18-19<br>10 db / 10 Pcs<br>21-22-23-24-26-27-28-30-32<br>5 db / 5 Pcs | 18.236 | 1 |

1113

## 1/2"-os dugókulcs

Socket Wrench 6 Points (mm)



TS ISO 2725 -1  
DIN 3124

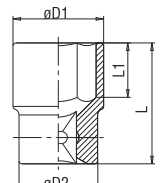

1/2"

Krómozott fényes felületű  
króm-vanádium

Chrom vanadium, Chrom plated

| KÓD<br>CODE  | mm | σ D1<br>mm | σ D2<br>mm | L<br>mm | L1<br>mm | g   |    |
|--------------|----|------------|------------|---------|----------|-----|----|
| 1113 06 1008 | 8  | 14         | 22         | 38      | 7        | 55  | 10 |
| 1113 06 1009 | 9  | 14.1       | 22         | 38      | 7        | 55  | 10 |
| 1113 06 1010 | 10 | 15.4       | 22         | 38      | 8        | 55  | 10 |
| 1113 06 1011 | 11 | 16.6       | 22         | 38      | 8        | 60  | 10 |
| 1113 06 1012 | 12 | 17.8       | 22         | 38      | 9        | 60  | 10 |
| 1113 06 1013 | 13 | 19         | 22         | 38      | 10       | 65  | 10 |
| 1113 06 1014 | 14 | 20.4       | 22         | 38      | 11       | 65  | 10 |
| 1113 06 1015 | 15 | 21.6       | 22         | 38      | 11       | 65  | 10 |
| 1113 06 1016 | 16 | 22.9       | 22         | 38      | 11       | 70  | 10 |
| 1113 06 1017 | 17 | 24         | 22         | 38      | 12       | 70  | 10 |
| 1113 06 1018 | 18 | 25.4       | 23         | 38      | 13       | 75  | 10 |
| 1113 06 1019 | 19 | 26.6       | 23         | 38      | 13       | 75  | 10 |
| 1113 06 1020 | 20 | 28         | 24         | 38      | 13       | 80  | 10 |
| 1113 06 1021 | 21 | 29.2       | 24         | 38      | 13       | 85  | 5  |
| 1113 06 1022 | 22 | 30.4       | 26         | 38      | 15       | 95  | 5  |
| 1113 06 1023 | 23 | 31.2       | 28         | 38      | 15       | 100 | 5  |
| 1113 06 1024 | 24 | 32.9       | 28         | 38      | 17       | 115 | 5  |
| 1113 06 1025 | 25 | 33.2       | 29         | 42      | 17       | 125 | 5  |
| 1113 06 1026 | 26 | 34         | 30         | 42      | 17       | 135 | 5  |
| 1113 06 1027 | 27 | 36.6       | 30         | 42      | 19       | 140 | 5  |
| 1113 06 1028 | 28 | 37.5       | 30         | 42      | 20       | 160 | 5  |
| 1113 06 1029 | 29 | 39.5       | 32         | 42      | 21       | 170 | 5  |
| 1113 06 1030 | 30 | 40         | 32         | 44      | 21       | 180 | 5  |
| 1113 06 1032 | 32 | 43         | 34         | 44      | 23       | 190 | 5  |

Ne használja elektromos kéziszerszámmal  
/ Do not use with power-tools

1114

**1/2"-os dugókulcs, 12 szögű**  
Socket Wrench 12 Points (mm)

TS ISO 2725 - 1  
DIN 3124

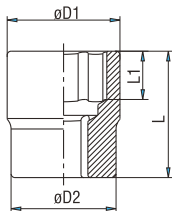

1/2"

**Krómozott fényes felületű**  
**króm-vanádium**  
Chrom vanadium, Chrom plated

| KÓD<br>CODE  | mm | σ D1<br>mm | σ D2<br>mm | L<br>mm | L1<br>mm | g   |    |
|--------------|----|------------|------------|---------|----------|-----|----|
| 1114 06 1010 | 10 | 15         | 23.3       | 38      | 8        | 60  | 10 |
| 1114 06 1011 | 11 | 16.4       | 23.3       | 38      | 8        | 60  | 10 |
| 1114 06 1012 | 12 | 17.8       | 23.3       | 38      | 9        | 60  | 10 |
| 1114 06 1013 | 13 | 19         | 23.3       | 38      | 10       | 60  | 10 |
| 1114 06 1014 | 14 | 20.4       | 23.3       | 38      | 11       | 60  | 10 |
| 1114 06 1015 | 15 | 21.6       | 23.3       | 38      | 11       | 65  | 10 |
| 1114 06 1016 | 16 | 22.9       | 24         | 38      | 11       | 70  | 10 |
| 1114 06 1017 | 17 | 24         | 22.5       | 38      | 12       | 70  | 10 |
| 1114 06 1018 | 18 | 25.2       | 23         | 38      | 13       | 70  | 10 |
| 1114 06 1019 | 19 | 26.8       | 23         | 38      | 13       | 75  | 10 |
| 1114 06 1020 | 20 | 28         | 23         | 38      | 13       | 80  | 10 |
| 1114 06 1021 | 21 | 29.2       | 23         | 38      | 13       | 80  | 5  |
| 1114 06 1022 | 22 | 30.2       | 24         | 40      | 15       | 95  | 5  |
| 1114 06 1023 | 23 | 31.4       | 25         | 40      | 15       | 100 | 5  |
| 1114 06 1024 | 24 | 32.6       | 26         | 42      | 17       | 105 | 5  |
| 1114 06 1026 | 26 | 35.3       | 28         | 42      | 17       | 135 | 5  |
| 1114 06 1027 | 27 | 36.6       | 28         | 42      | 19       | 135 | 5  |
| 1114 06 1028 | 28 | 37.8       | 30         | 42      | 20       | 155 | 5  |
| 1114 06 1030 | 30 | 40         | 30         | 44      | 21       | 165 | 5  |
| 1114 06 1032 | 32 | 42.5       | 30         | 44      | 23       | 180 | 5  |

1513

**Adapter**  
Adapter

TS ISO 3316  
DIN 3123



1/2"

**Krómozott, króm-vanádium**  
Chrom vanadium, Chrom plated

| KÓD<br>CODE  | inch       | g   |   |
|--------------|------------|-----|---|
| 1513 06 0002 | 1/2"x3/8"M | 55  | 5 |
| 1513 06 0003 | 1/2"x3/4"M | 115 | 5 |

1108

**1/2"-os dugókulcs,**  
**hosszított, 75 mm**  
Deep Socket Wrench 6 Points (mm)

TS ISO 2725 - 1  
DIN 3124

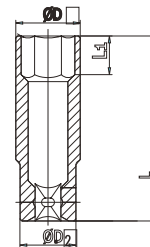

1/2"

**Krómozott, fényes felületű**  
**króm-vanádium**  
Chrom vanadium, Chrom plated

| KÓD<br>CODE  | mm | øD1<br>mm | øD2<br>mm | L<br>mm | L1<br>mm | g   |    |
|--------------|----|-----------|-----------|---------|----------|-----|----|
| 1108 06 0010 | 10 | 15.2      | 22        | 75      | 6        | 110 | 10 |
| 1108 06 0011 | 11 | 16.7      | 24        | 75      | 7        | 110 | 10 |
| 1108 06 0012 | 12 | 18        | 24        | 75      | 8        | 110 | 10 |
| 1108 06 0013 | 13 | 19        | 24        | 75      | 8        | 120 | 10 |
| 1108 06 0014 | 14 | 20.5      | 24        | 75      | 10       | 120 | 10 |
| 1108 06 0015 | 15 | 21.7      | 24        | 75      | 10       | 140 | 10 |
| 1108 06 0016 | 16 | 22        | 25.5      | 75      | 10       | 140 | 10 |
| 1108 06 0017 | 17 | 24        | 25.5      | 75      | 10       | 140 | 10 |
| 1108 06 0018 | 18 | 25.5      | 25.5      | 75      | 12       | 150 | 10 |
| 1108 06 0019 | 19 | 26        | 25.5      | 75      | 12       | 150 | 10 |

1513

**Hosszabbító szár**  
Extension Bar

TS ISO 3316  
DIN 3123



1/2"

**Krómozott, króm-vanádium**  
Chrom vanadium, Chrom plated

| KÓD<br>CODE  | L<br>mm | g   |   |
|--------------|---------|-----|---|
| 1513 06 4075 | 75      | 140 | 5 |
| 1513 06 4125 | 125     | 215 | 5 |
| 1513 06 4250 | 250     | 420 | 5 |

1513

## 1/2"-os csuklós csatlakozó

### Universal Joint

TS ISO 3316  
DIN 3123



1/2"

Krómozott, króm-vanádium  
Chrom vanadium, Chrom plated

| KÓD<br>CODE  | L<br>mm | g   | □ |
|--------------|---------|-----|---|
| 1513 06 4070 | 70      | 140 | 5 |

1513

## Racsnis hajtókar

### Ratchet Handle (32 Teeth)

TS ISO 3315  
DIN3122



1/2"

Krómozott, króm-vanádium  
Chrom vanadium, Chrom plated

| KÓD<br>CODE  | L<br>mm | g   | □ |        |
|--------------|---------|-----|---|--------|
| 1513 06 0032 | 250     | 580 | 5 | 641,00 |

1113

## 1/2"-os dugókulcsfej Torx

### Star Torx Socket Wrench

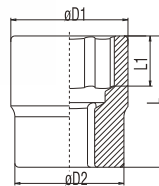

1/2"

Krómozott fényes felületű  
króm-vanádium  
Chrom vanadium, Chrom plated

| KÓD<br>CODE  | □   | ø D1<br>mm | ø D2<br>mm | L<br>mm | L1<br>mm | g  | □  |
|--------------|-----|------------|------------|---------|----------|----|----|
| 1113 06 0210 | E10 | 13.2       | 23.8       | 37      | 7.5      | 60 | 10 |
| 1113 06 0212 | E12 | 15         | 23.8       | 37      | 9        | 65 | 10 |
| 1113 06 0214 | E14 | 16.4       | 23.8       | 37      | 10       | 65 | 10 |
| 1113 06 0216 | E16 | 18.8       | 23.8       | 37      | 11       | 70 | 10 |
| 1113 06 0218 | E18 | 20.5       | 23.8       | 39      | 12.5     | 75 | 10 |
| 1113 06 0220 | E20 | 23         | 23.8       | 39      | 14       | 75 | 10 |

1113

## 1/2"-os Torx bitfej

### Star (Torx) Bit Socket Wrench



1/2"

Krómozott fényes felületű  
króm-vanádium  
Chrom vanadium, Chrom plated

| KÓD<br>CODE  | ★   | L<br>mm | g   | □  |
|--------------|-----|---------|-----|----|
| 1113 06 1220 | T20 | 60      | 70  | 10 |
| 1113 06 1225 | T25 | 60      | 70  | 10 |
| 1113 06 1227 | T27 | 60      | 70  | 10 |
| 1113 06 1230 | T30 | 60      | 70  | 10 |
| 1113 06 1240 | T40 | 60      | 70  | 10 |
| 1113 06 1245 | T45 | 60      | 70  | 10 |
| 1113 06 1250 | T50 | 60      | 75  | 10 |
| 1113 06 1255 | T55 | 60      | 80  | 10 |
| 1113 06 1260 | T60 | 60      | 100 | 10 |
| 1113 06 4220 | T20 | 100     | 78  | 10 |
| 1113 06 4225 | T25 | 100     | 79  | 10 |
| 1113 06 4227 | T27 | 100     | 80  | 10 |
| 1113 06 4230 | T30 | 100     | 80  | 10 |
| 1113 06 4240 | T40 | 100     | 80  | 10 |
| 1113 06 4245 | T45 | 100     | 82  | 10 |
| 1113 06 4250 | T50 | 100     | 82  | 10 |
| 1113 06 4255 | T55 | 100     | 100 | 10 |
| 1113 06 4260 | T60 | 100     | 134 | 10 |

## 1/2"-os dugókulcskészlet, 24 darabos

Socket Wrench Set 12 Points (24 pcs, mm)



1/2"

| KÓD<br>CODE  | KULCSOK<br>Sockets   | TARTOZÉKOK<br>Accessories                         | g    |    |
|--------------|--|---|------|----|
|              |  | 1/2" Círcir Kolu<br>Ratchet Handle                |      |    |
|              |  | 1/2" Mafsal<br>Universal Joint                    |      |    |
| 1114 00 6024 | 10 - 11 - 12 13 -<br>14 - 15<br>16 - 17 - 18<br>19 - 21 - 22<br>23 - 24 - 26<br>27 - 28 - 30<br>32 | 1/2" T Kol Adaptör<br>Sliding T Handle<br>Adapter | 4150 | 24 |
|              |  | 1/2" Ara Kol<br>Extension Bar<br>125 mm           |      |    |
|              |  | 1/2" Ara Kol<br>Extension Bar<br>250 mm           |      |    |

Ne használja elektromos kéziszerszámmal  
/ Do not use with power-tools

1113

## 1/2"-os gépi dugókulcs Impact Socket Wrench 6 Points (mm)

TS ISO 2725-2

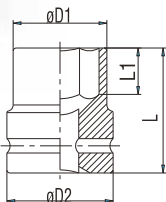

1/2"

Króm-molibdén, edzett felületű  
Chrom molydenum, Photosphate finish

| KÓD<br>CODE  | mm | σ D1<br>mm | σ D2<br>mm | L<br>mm | L1<br>mm | g   |    |
|--------------|----|------------|------------|---------|----------|-----|----|
| 1113 06 7010 | 10 | 17         | 25         | 38      | 8        | 70  | 10 |
| 1113 06 7011 | 11 | 18         | 25         | 38      | 8        | 70  | 10 |
| 1113 06 7012 | 12 | 19         | 25         | 38      | 9        | 70  | 10 |
| 1113 06 7013 | 13 | 20         | 25         | 38      | 10       | 70  | 10 |
| 1113 06 7014 | 14 | 22         | 25         | 38      | 10       | 75  | 10 |
| 1113 06 7015 | 15 | 23         | 30         | 38      | 11       | 110 | 10 |
| 1113 06 7016 | 16 | 24         | 30         | 38      | 11       | 110 | 10 |
| 1113 06 7017 | 17 | 26         | 30         | 38      | 12       | 115 | 10 |
| 1113 06 7018 | 18 | 27         | 30         | 38      | 13       | 115 | 10 |
| 1113 06 7019 | 19 | 28         | 30         | 38      | 13       | 120 | 10 |
| 1113 06 7021 | 21 | 30         | 30         | 40      | 14       | 125 | 5  |
| 1113 06 7022 | 22 | 32         | 30         | 40      | 14       | 145 | 5  |
| 1113 06 7024 | 24 | 34         | 30         | 42      | 15       | 150 | 5  |
| 1113 06 7027 | 27 | 38         | 30         | 44      | 16       | 175 | 5  |

1513

## 1/2"-os gépi dugókulcs hosszabbító szár Impact Socket Extension Bar



1/2"

Króm-molibdén, edzett felületű  
Chrom molydenum, Photosphate finish

| KÓD<br>CODE  | L<br>mm | g   |   |
|--------------|---------|-----|---|
| 1513 06 7125 | 125     | 275 | 5 |

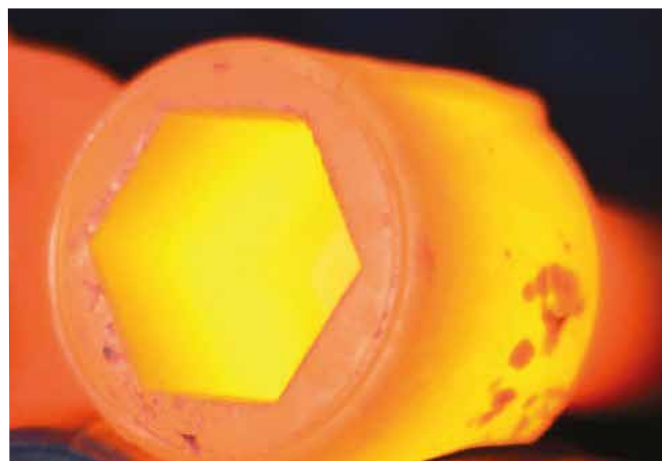



1119

## 3/4"-os dugókulcs

### Socket Wrench 6 Points (mm)

TS ISO 2725 -1  
DIN 3124

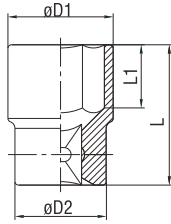

3/4"

Krómozott, króm-vanádium  
Chrom vanadium, Chrom plated

| KÓD<br>CODE  | mm | σ D1<br>mm | σ D2<br>mm | L<br>mm | L1<br>mm | g    |   |
|--------------|----|------------|------------|---------|----------|------|---|
| 1119 06 1022 | 22 | 33         | 36         | 52      | 16       | 225  | 5 |
| 1119 06 1024 | 24 | 35         | 36         | 52      | 16       | 230  | 5 |
| 1119 06 1027 | 27 | 38         | 36         | 52      | 19       | 235  | 5 |
| 1119 06 1030 | 30 | 42         | 38         | 54      | 21       | 300  | 5 |
| 1119 06 1032 | 32 | 44         | 38         | 56      | 23       | 320  | 5 |
| 1119 06 1034 | 34 | 47         | 42         | 58      | 24       | 400  | 5 |
| 1119 06 1036 | 36 | 50         | 42         | 58      | 25       | 440  | 5 |
| 1119 06 1038 | 38 | 52         | 45         | 60      | 27       | 500  | 5 |
| 1119 06 1041 | 41 | 56         | 45         | 64      | 29       | 580  | 1 |
| 1119 06 1046 | 46 | 62         | 48         | 68      | 33       | 730  | 1 |
| 1119 06 1050 | 50 | 68         | 48         | 72      | 34       | 885  | 1 |
| 1119 06 1055 | 55 | 74         | 48         | 76      | 37       | 1070 | 1 |
| 1119 06 1060 | 60 | 80         | 48         | 78      | 38       | 1170 | 1 |

1519

## 3/4"-os hosszabbító szár

### Extension Bar

TS ISO 3316  
DIN 3123



3/4"

Krómozott, króm-vanádium  
Chrom vanadium, Chrom plated

| KÓD<br>CODE  | L<br>mm | g    |   |
|--------------|---------|------|---|
| 1519 06 4200 | 200     | 730  | 5 |
| 1519 06 4400 | 400     | 1370 | 5 |



3020

**Szigetelt kombinált fogó 1000 V**  
Electrician Type Insulated  
Combination Pliers 1000V



TS 60  
TS ISO 5746  
DIN ISO 5746

⚡ 1000 V  
IEC 60900



**Speciális acél, erősített, krómozott**

Special steel, Cutters induction hardened, Chrom plated

| KÓD<br>CODE  | L<br>mm | L<br>inch | g   | □ |
|--------------|---------|-----------|-----|---|
| 3020 12 6160 | 160     | 6 1/4"    | 205 | 5 |
| 3020 12 6180 | 180     | 7 1/8"    | 260 | 5 |
| 3020 12 6200 | 200     | 8"        | 345 | 5 |

3030

**Kombinált fogó**  
Combination Pliers Heavy Duty  
(for piano wire)



**Speciális acél, erősített**

Special steel, Cutters induction hardened

| KÓD<br>CODE  | L<br>mm | L<br>inch | g   | □ |
|--------------|---------|-----------|-----|---|
| 3030 12 2180 | 180     | 7 1/8"    | 285 | 5 |
| 3030 12 2200 | 200     | 8"        | 380 | 5 |

3700

**Szigetelt oldalvágó fogó 1000 V**  
Insulated Electrician Type  
Side Cutter 1000V



TS 60  
TS ISO 5749  
DIN ISO 5749

⚡ 1000 V  
IEC 60900



**Speciális acél, erősített, krómozott**

Special steel, Cutters induction hardened, Chrom plated

| KÓD<br>CODE  | L<br>mm | L<br>inch | g   | □ |
|--------------|---------|-----------|-----|---|
| 3700 16 6160 | 160     | 6 1/4"    | 215 | 5 |
| 3700 16 6180 | 180     | 7 1/8"    | 225 | 5 |

3700

**Oldalvágó fogó**  
Side Cutting Pliers



TS 60 - TS ISO 5749  
DIN ISO 5749

**Speciális acél, erősített, krómozott**  
Special steel, Cutters induction hardened

| KÓD<br>CODE  | L<br>mm | L<br>inch | g   | □ |
|--------------|---------|-----------|-----|---|
| 3700 16 2140 | 140     | 5 1/2"    | 165 | 5 |
| 3700 16 2160 | 160     | 6 1/4"    | 230 | 5 |
| 3700 16 2180 | 180     | 7 1/8"    | 230 | 5 |

3730

**Erősített oldalvágó fogó**  
Side Cutter Heavy Duty (for piano wire)



**Speciális acél, erősített, krómozott**  
Special steel, Cutters induction hardened

| KÓD<br>CODE  | L<br>mm | L<br>inch | g   | □ |
|--------------|---------|-----------|-----|---|
| 3730 16 2160 | 160     | 6 1/4"    | 200 | 5 |
| 3730 16 2200 | 200     | 8"        | 320 | 5 |

2415

**Nyomógombos vízpumpafogó**  
Waterpump Pliers With Spring



| KÓD<br>CODE  | L<br>mm | L<br>inch | mm | g   | □ |
|--------------|---------|-----------|----|-----|---|
| 2415 11 0240 | 240     | 9 1/2"    | 35 | 365 | 5 |

**Krómozott fekete felületű  
PVC szigetelésű**

Chrom vanadium, Black finish, PVC insulated

## Oldalvágó fogó / SIDE CUTTING PLIERS

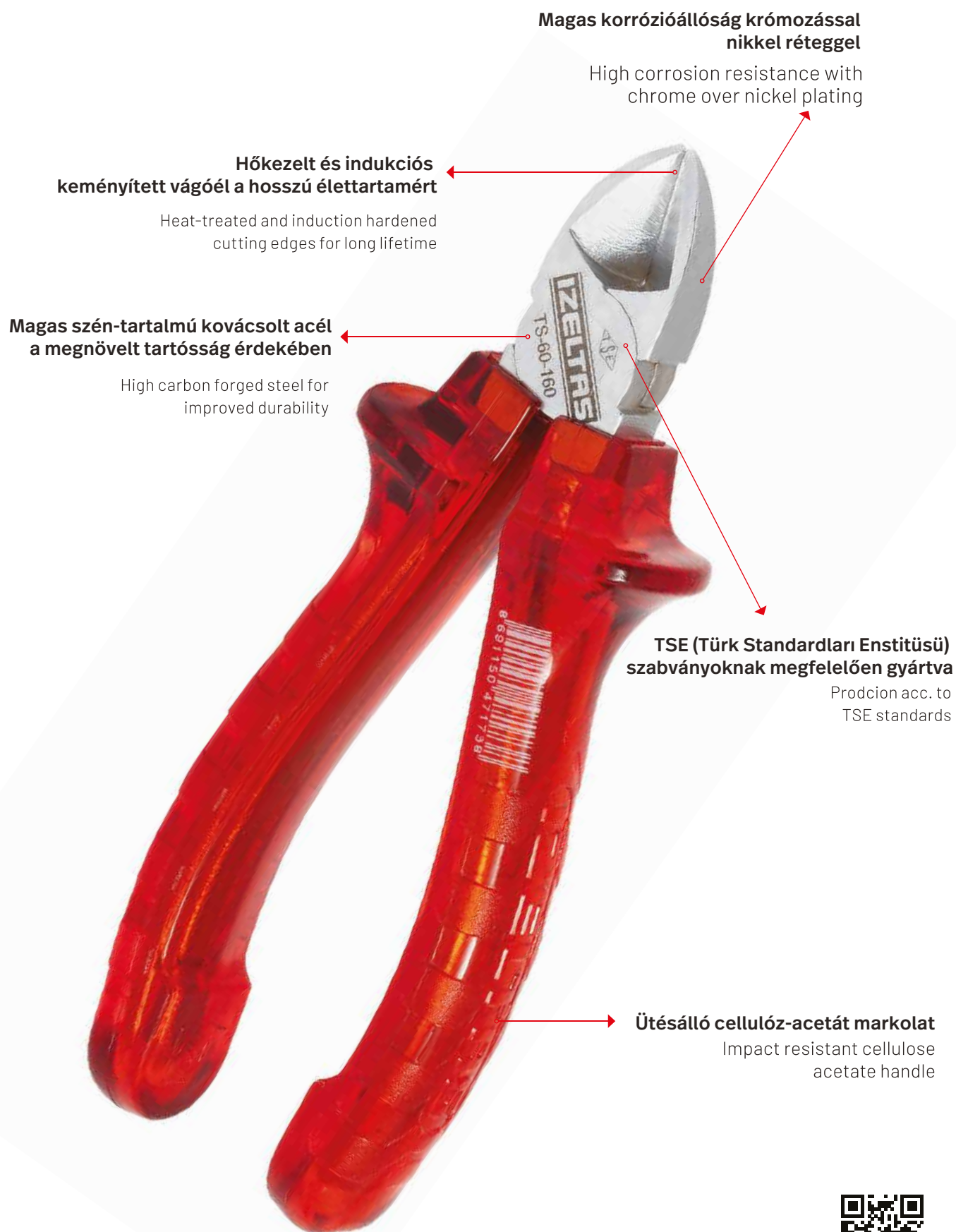

**Magas korrózióállóság krómozással  
nikkel réteggel**

High corrosion resistance with  
chrome over nickel plating

**Hőkezelt és indukciós  
keményített vágóél a hosszú élettartamért**

Heat-treated and induction hardened  
cutting edges for long lifetime

**Magas szén-tartalmú kovácsolt acél  
a megnövelt tartósság érdekében**

High carbon forged steel for  
improved durability

**TSE (Türk Standardları Enstitüsü)  
szabványoknak megfelelően gyártva**

Prodicion acc. to  
TSE standards

**Ütésálló cellulóz-acetát markolat**

Impact resistant cellulose  
acetate handle



İZELTAŞ YOUTUBE

## Seeger Fogó készlet (4 db)

### Circlip Pliers Set (4 Pcs)



İZELTAŞ YOUTUBE



330112 0180



3311 12 0170



3321 12 0180



3331 12 0170

| KÓD<br>CODE  | L<br>mm | TARTALMA<br>CONTENTS   |   |
|--------------|---------|--|---|
| 3301 12 0180 | 180     | Seeger Fogó, külső, egyenes<br>Circlip Pliers, External (Flat)   | 1 |
| 3311 12 0170 | 170     | Seeger Fogó, külső, hajlított<br>Circlip Pliers, External (Bent) | 1 |
| 3321 12 0180 | 180     | Seeger Fogó, belső, egyenes<br>Circlip Pliers, Internal (Flat)   | 1 |
| 3331 12 0170 | 170     | Seeger Fogó, belső, hajlított<br>Circlip Pliers, Internal (Bent) | 1 |

## 3700

## Oldalvágó fogó

### Side Cutting Pliers



DIN ISO 5749  
TS 60 - TS ISO 5749



Speciális acél, erősített, krómozott  
Special steel, Cutters induction hardened

| KÓD<br>CODE  | L<br>mm | L<br>inch | <br>g |   |
|--------------|---------|-----------|-------|---|
| 3700 16 3160 | 160     | 6 1/4"    | 240   | 5 |
| 3700 16 3180 | 180     | 7 1/8"    | 255   | 5 |





**4140**

## Szigetelt csavarhúzó készlet (6 db) 1000 V

Insulated Electrician Set (6 Pcs)  
Screwdriver 1000V



| KÓD<br>CODE  | TARTALMA<br>CONTENTS  | g   | □ |  |
|--------------|---|-----|---|--|
| 4140 00 9106 |  2.5x75 - 4x100<br>5.5x125 - 6.5x150 | 340 | 6 |  |
|              |  4.5x80 - 6x100                     |     |   |  |

**4773**

## Szigetelt hatlapú nyeles dugókulcs készlet (8 db) 1000 V

Nut Spinner,  
Electrician Blade Insulated Set (8 Pcs) 1000V



| KÓD<br>CODE  | TARTALMA<br>CONTENTS              | g    | □ |  |
|--------------|-----------------------------------|------|---|--|
| 4773 00 8108 | 6 - 7 - 8 - 9 - 10 - 11 - 12 - 13 | 2225 | 8 |  |

**8795 00 6005**

## Szigetelt szerszámkészlet (5 db) 1000V Insulated Tool Set (5 Pcs)



| KÓD<br>CODE  | TARTALMA<br>CONTENTS  | □ |  |
|--------------|---|---|--|
| 3020 12 6180 | <b>Szigetelt kombinált fogó</b><br>Insulated Electrician Type Combination Pliers<br>1000V       | 1 |  |
| 3220 13 6200 | <b>Szigetelt csőrősfogó</b><br>Insulated Electrician Type Nose Pliers                           | 1 |  |
| 3700 16 6160 | <b>Szigetelt oldalvágó fogó</b><br>Insulated Electrician Type Nose                              | 1 |  |
| 4140 17 5512 | <b>Szigetelt lapos csavarhúzó</b><br>Insulated Electrician Type Flat Screwdriver 1000V          | 1 |  |
| 4145 18 6100 | <b>Szigetelt Philips csavarhúzó</b><br>Insulated Electrician Type Phillips Screwdriver<br>1000V | 1 |  |

4100

## Csavarhúzó készlet (7 db)

### Screwdriver Set, Kraft (7 Pcs)



| KÓD<br>CODE  | TARTALMA<br>CONTENTS                  | g   |   |
|--------------|---------------------------------------|-----|---|
| 4100 00 8107 | 3x80 - 4x80 - 4x100                   | 445 | 7 |
|              | 5x125 - 6x150<br>Lapos / Flat         |     |   |
|              | 4.5x80 - 6x100<br>Phillips / Phillips |     |   |

4300

## Csavarhúzó készlet (7 db)

### Screwdriver Set, Opak (7 Pcs)



| KÓD<br>CODE  | TARTALMA<br>CONTENTS                  | g   |   |
|--------------|---------------------------------------|-----|---|
| 4300 00 8107 | 3x80 - 4x80 - 4x100                   | 520 | 7 |
|              | 5x125 - 6x150<br>Lapos / Flat         |     |   |
|              | 4.5x80 - 6x100<br>Phillips / Phillips |     |   |
|              |                                       |     |   |

6230

## Zsírzófej

### Grease Gun Nozzle



500cc  
300cc

| KÓD<br>CODE  | L<br>mm | ø<br>mm | g  |    |
|--------------|---------|---------|----|----|
| 6230 26 2500 | 38      | 15      | 31 | 10 |

## Zsírzócső

### Hose for



| KÓD<br>CODE  | ø<br>mm | L<br>mm | g   |    |
|--------------|---------|---------|-----|----|
| 6230 26 3300 | 8       | 300     | 34  | 10 |
| 6230 26 3500 | 12      | 500     | 102 | 10 |



## TERÜLETI KÉPVISELŐK ELÉRHETŐSÉGEI

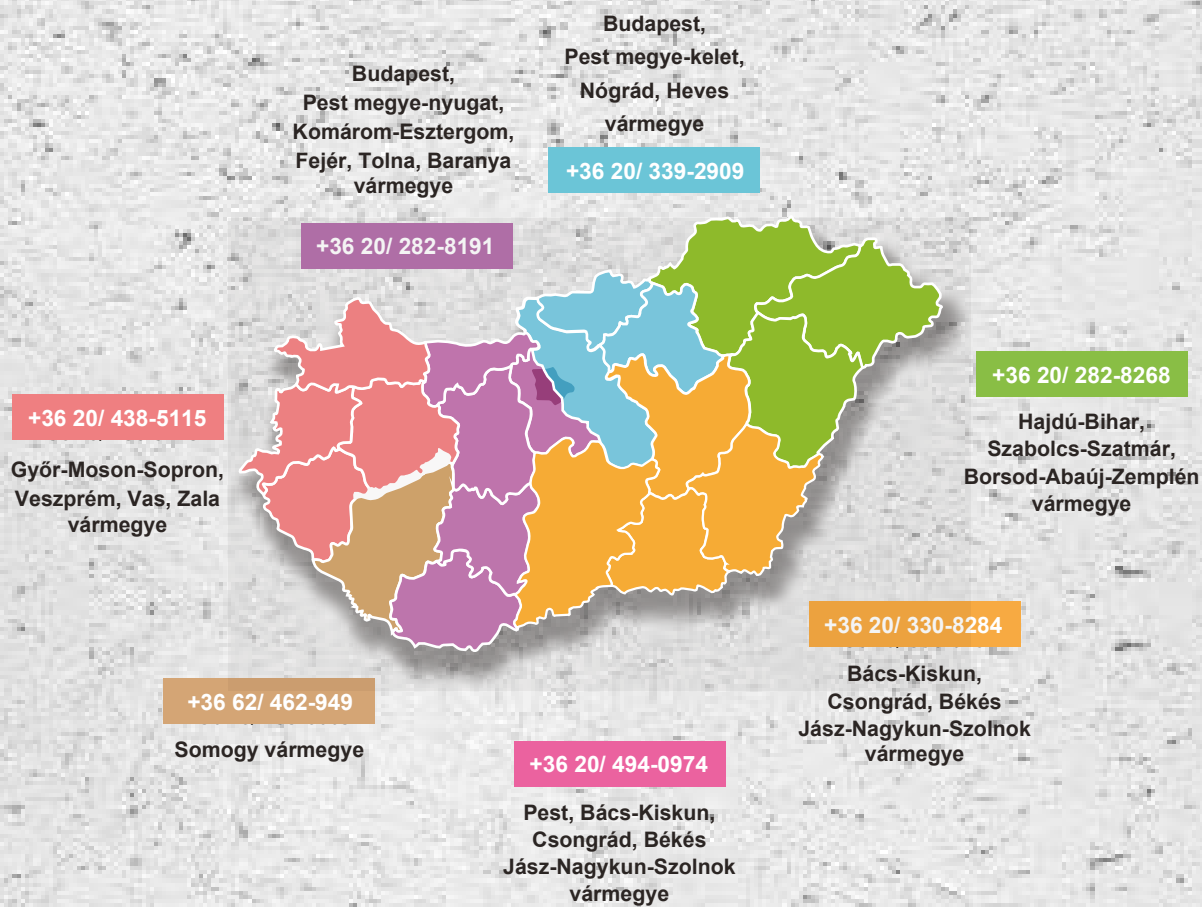

**flexovit**  
HUNGÁRIA KFT.

Flexovit Hungária Kft  
6728 Szeged, Dorozsmai út 48.  
E-mail: [flexovit@flexovit.hu](mailto:flexovit@flexovit.hu)  
Tel: +36 62/462-949  
Web: [www.flexshop.hu](http://www.flexshop.hu)